

# 1766096PCOM CARSON FIREPLACE TV STAND

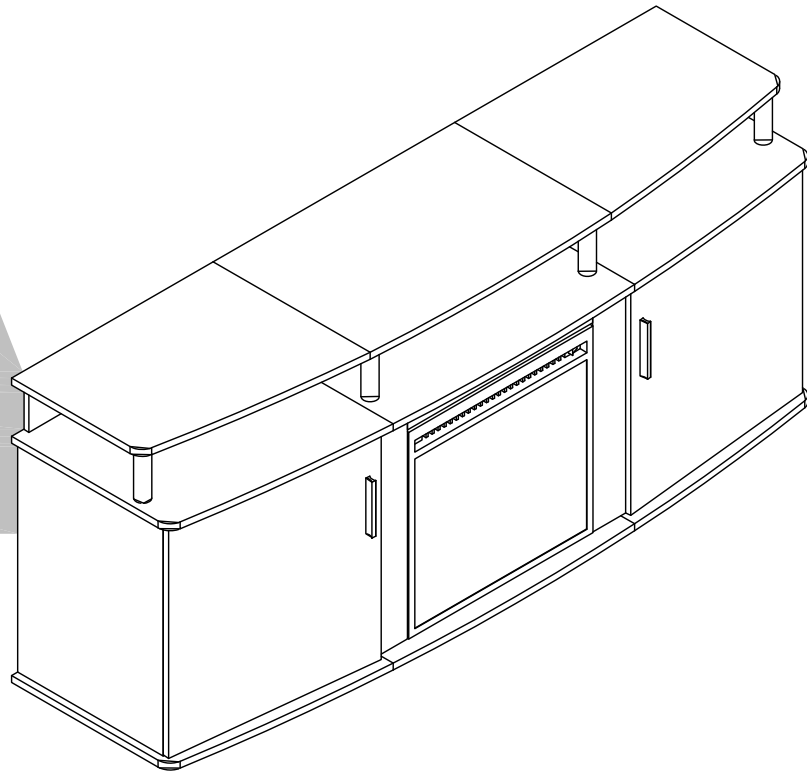

Date of Purchase \_\_\_ / \_\_\_ / \_\_\_  
Lot Number:

B341766096PCOM00KX



THIS INSTRUCTION BOOKLET CONTAINS **IMPORTANT** SAFETY INFORMATION. PLEASE READ AND KEEP FOR FUTURE REFERENCE.

### Do Not Return This Product!

Contact our customer service team for help first.

**Call:** 1-800-489-3351 (toll free)

Monday-Friday 9am - 5pm CST

**Visit:** [www.ameriwoodhome.com](http://www.ameriwoodhome.com)

## WARNING

- Unit can tip over causing severe injury or death.
- Anchor unit to stud in wall (if instructed to).
- Do Not allow children to climb on unit.
- Put heavy items on lower shelves or drawers.



Follow Ameriwood Home



# Contact Us!

## Do NOT return this product!

Contact our friendly customer service team first for help.

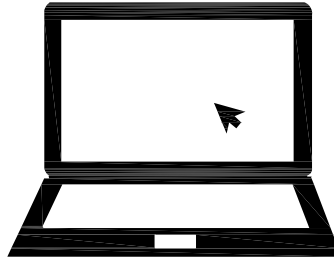

Visit [ameriwoodhome.com](http://ameriwoodhome.com)

Assembly Tips



# Helpful Hints

PEOPLE NEEDED FOR ASSEMBLY: 1-2  
ESTIMATED ASSEMBLY TIME: 1-2 HOUR

- Open your item in the area you plan to keep it to avoid excessive heavy lifting.
- Identify, sort and count the parts before attempting assembly.
- Compression dowels are lightly tapped in with a hammer.
- Slides are labeled with a **R** (right) and **L** (left) for proper placement.
- Make sure to always face the point on the top of the Cam Lock towards the outer edge.
- Use all the nails provided for the back panel and spread them out equally.
- Back panel must be used to make sure your unit is sturdy.
- Do NOT use harsh chemicals or abrasive cleaners on this item.
- Never push, pull, or drag your furniture.

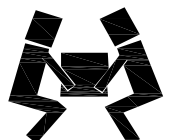
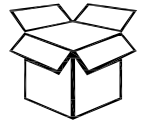

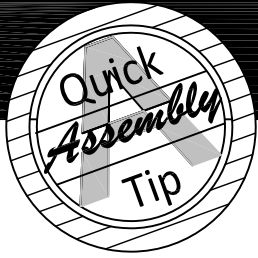

# Before You Start

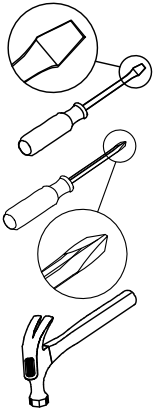

- ✓ Read through each step carefully and follow the proper order
- ✓ Separate and count all your parts and hardware
- ✓ Give yourself enough room for the assembly process
- ✓ Have the following tools: Flat Head Screwdriver, #2 Phillips Head Screwdriver and Hammer
- ✓ Caution: If using a power drill or power screwdriver for screwing, please be aware to slow down and stop when screw is tight. Failure to do so may result in stripping the screw.

# Cam Lock Fastening System

This Cam Lock Fastening System will be used throughout the assembly process.

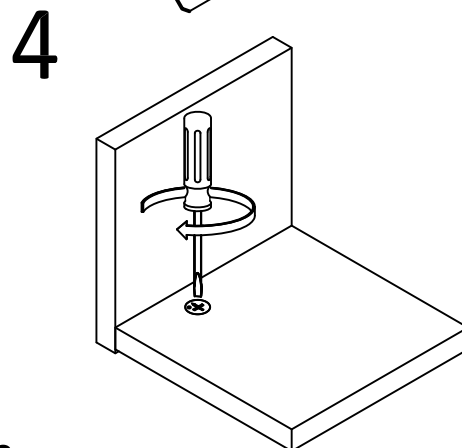
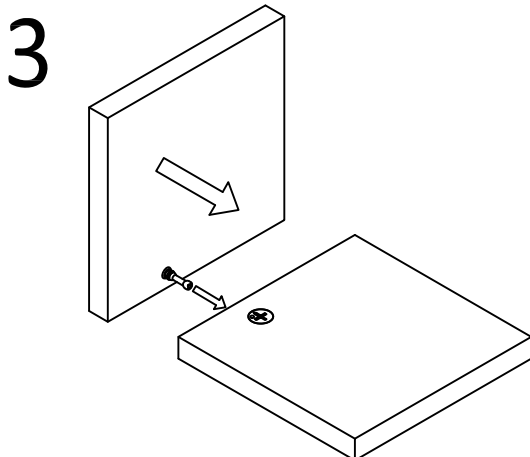
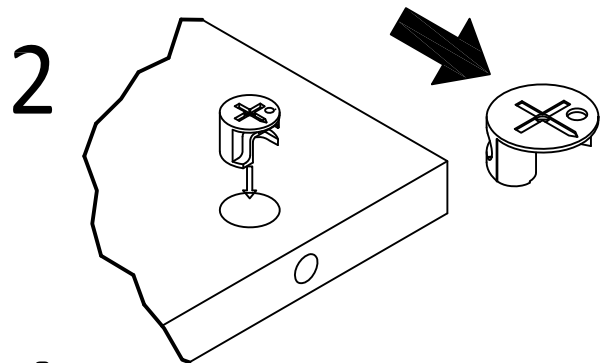
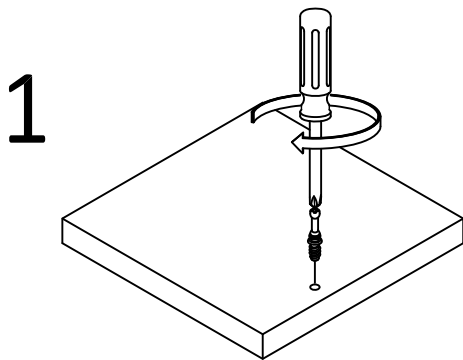

# Board Identification

Not Actual Size

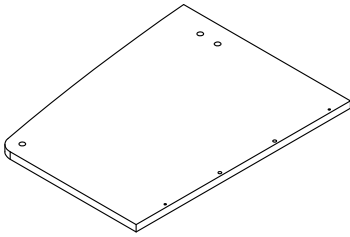

**A**  
Left top  
T1766096010KX

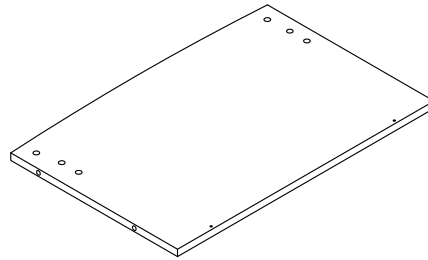

**B**  
Middle top  
T1766096020KX

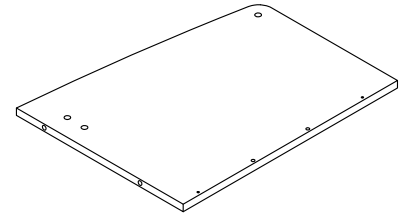

**C**  
Right top  
T1766096030KX

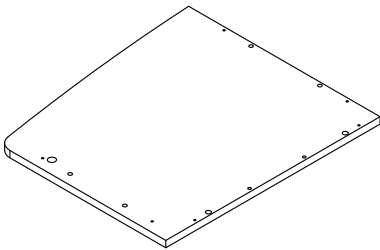

**D**  
Left shelf  
T1766096040KX

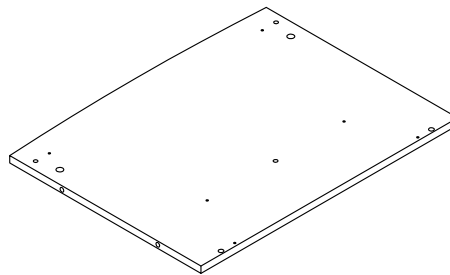

**E**  
Middle shelf  
T1766096050KX

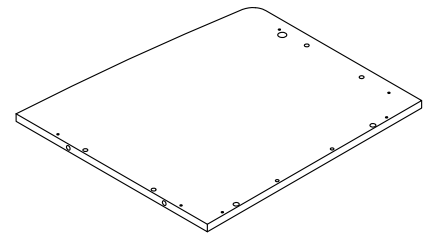

**F**  
Right shelf  
T1766096060KX

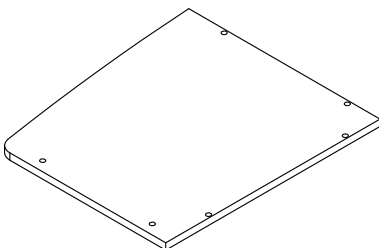

**G**  
Left bottom  
T1766096070KX

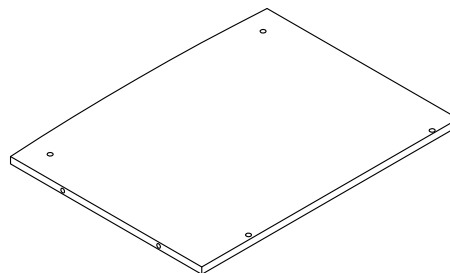

**H**  
Middle bottom  
T1766096080KX

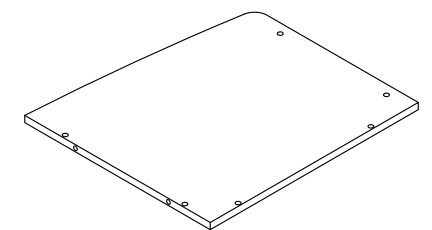

**I**  
Right bottom  
T1766096090KX

# Board Identification

Not Actual Size

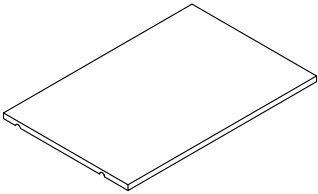

**J**

Adjustable shelf  
T1766096100KX  
QTY:2PCS

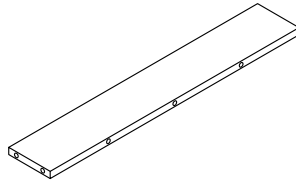

**K**

Support panel  
T1766096110KX

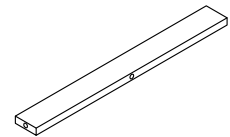

**L**

Top apron  
T1766096120KX

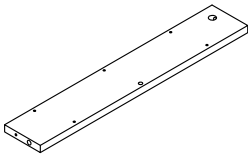

**M**

Left apron  
T1766096130KX

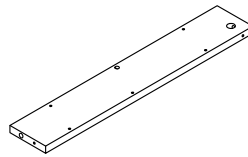

**N**

Right apron  
T1766096140KX

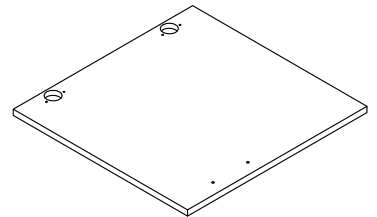

**O**

Left door  
T1766096150KX

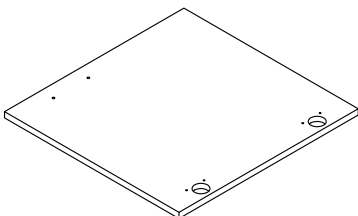

**P**

Right door  
T1766096160KX

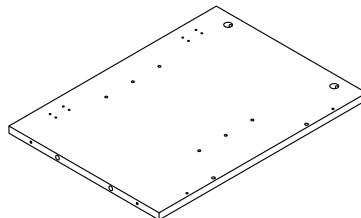

**Q**

Left side panel  
T1766096170KX

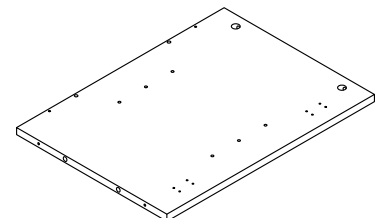

**R**

Right side panel  
T1766096180KX

# Board Identification

Not Actual Size

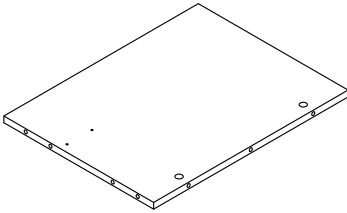

**S**

Left partition  
T1766096190KX

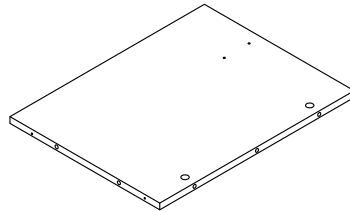

**T**

Right partition  
T1766096200KX

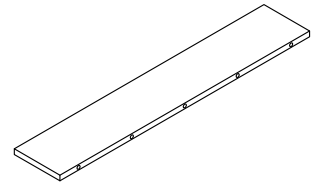

**U**

Left upper back panel  
T1766096210KX

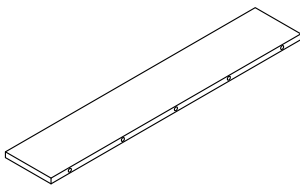

**V**

Right upper back panel  
T1766096220KX

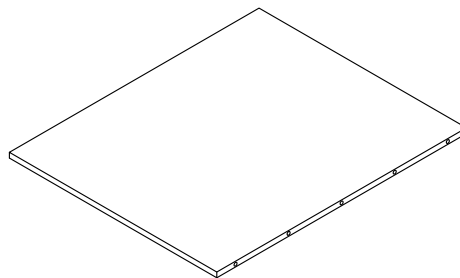

**W**

Left lower back panel  
T1766096230KX

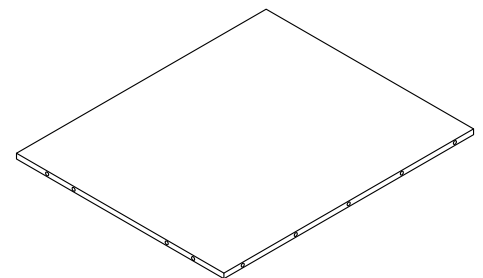

**X**

Right lower back panel  
T1766096240KX



**Y**

Support tube  
T1766096250KX  
QTY:4PCS

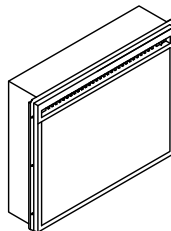

**Z**

Fireplace insert  
F18V66L

# Board Identification

Not actual size

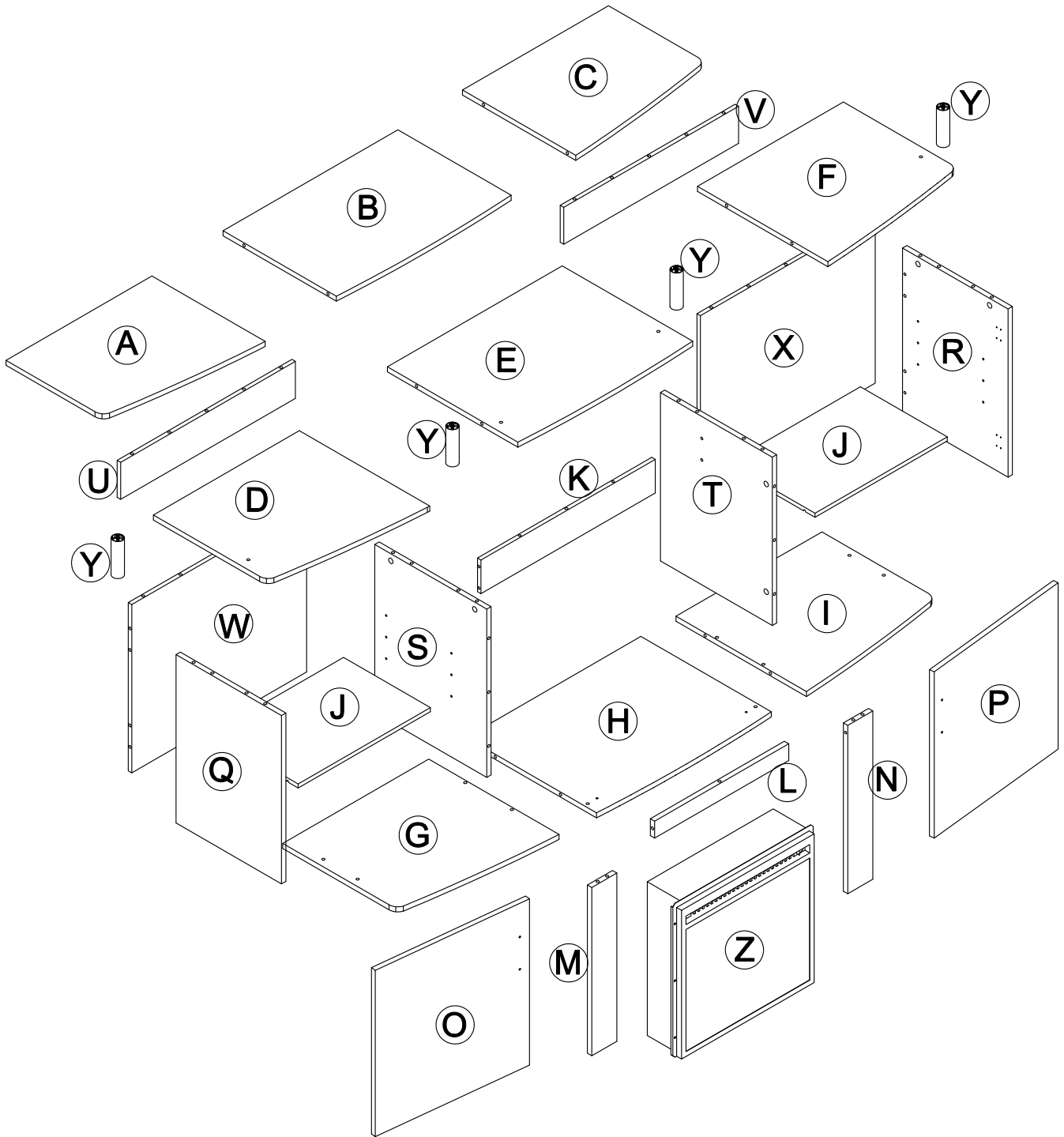

# Part List

## Actual Size

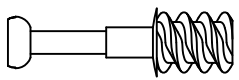

M8X20 mm

①	× 39
---	------

**Cam bolt  
TKX1195**

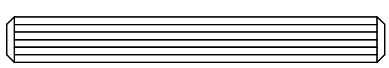

Ø6X50 mm

②	× 4
---	-----

**Wood dowel  
TKX1202**



Ø8X30 mm

③	× 35
---	------

**Wood dowel  
TKX1005**

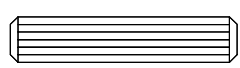

Ø6X30 mm

④	× 12
---	------

**Wood dowel  
TKX1006**

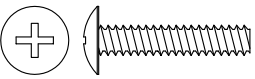

M4X20 mm

⑤	× 4
---	-----

**Bolt  
TKX1192**

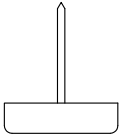

Ø15X4 mm

⑥	× 7
---	-----

**Tack glide  
TKX1179**

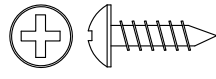

Ø4X14 mm

⑦	× 30
---	------

**Screw  
TKX1038**

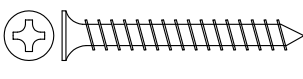

Ø4X32 mm

⑧	× 22
---	------

**Screw  
TKX1197**

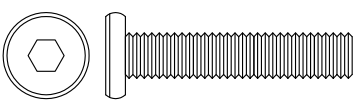

Ø1/4"X30 mm

⑨	× 4
---	-----

**Bolt  
TKX1198**

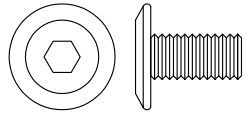

Ø1/4"X12mm

⑩	× 8
---	-----

**Bolt  
TKX1099**



# Part List

Not Actual Size

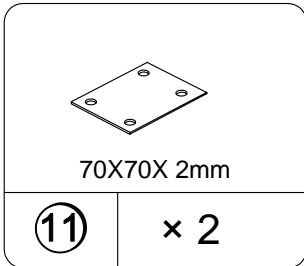

**Metal plate**  
TKX1224

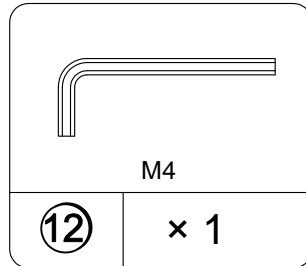

**Hex key**  
TKX1004

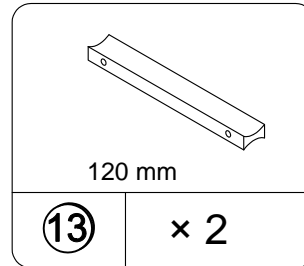

**Handle**  
TKX1226

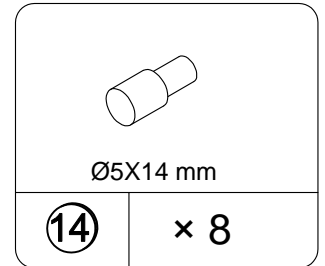

**Support pin**  
TKX1254

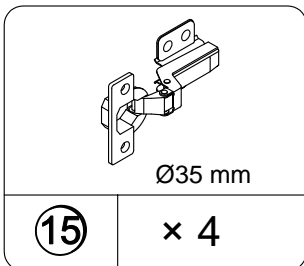

**Euro hinge**  
TKX1020

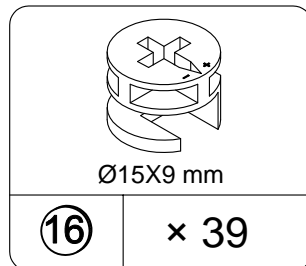

**Cam lock**  
TKX1023

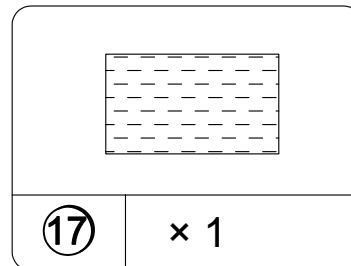

**Warning label**  
TKX3010

## STEP 1

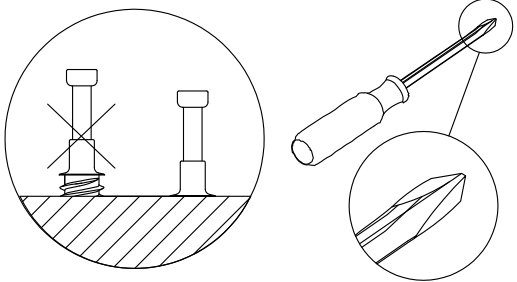
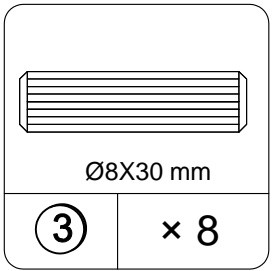
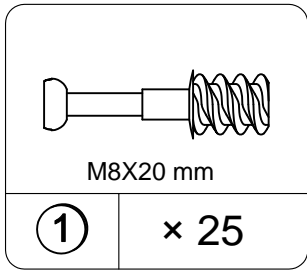

1.1 Attach (1) to (A), (B), (C), (D), (E) & (F) as illustrated.  
1.2 Insert (3) to (B) & (E) as illustrated.

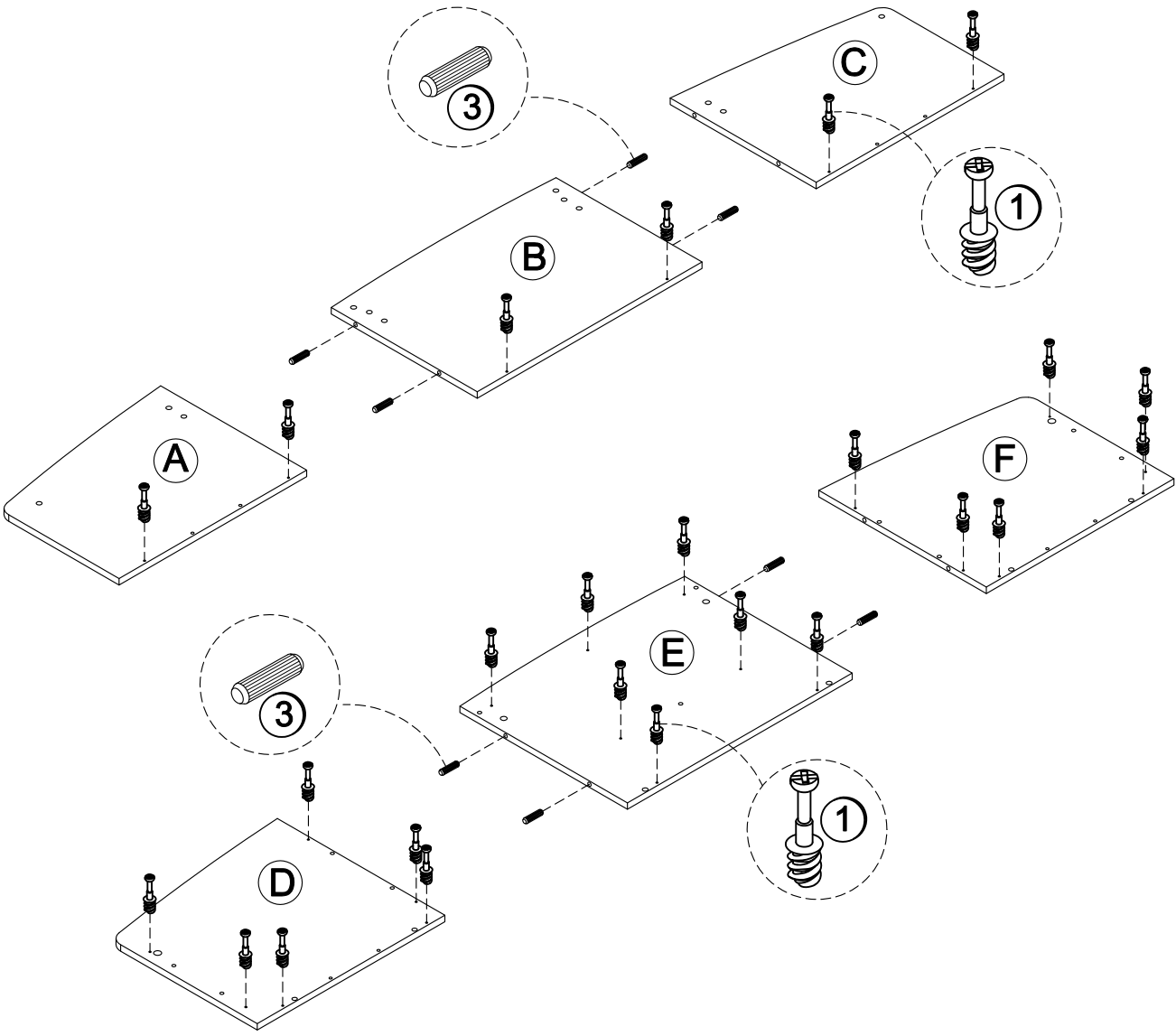

## STEP 2

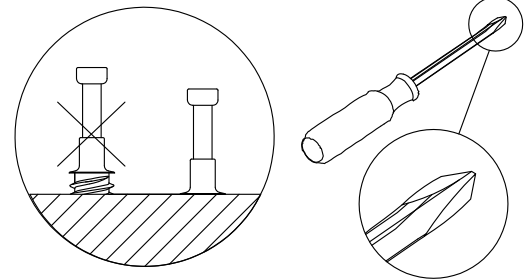
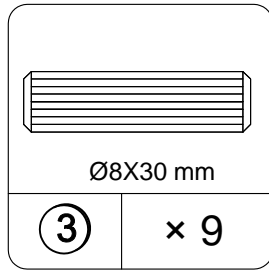
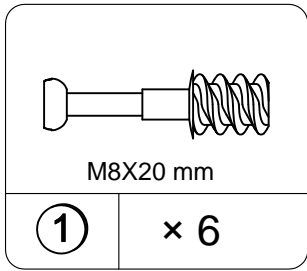

- 2.1 Attach (1) to (M) & (N) as illustrated.
- 2.2 Insert (3) to (H), (K), (M) & (N) as illustrated.

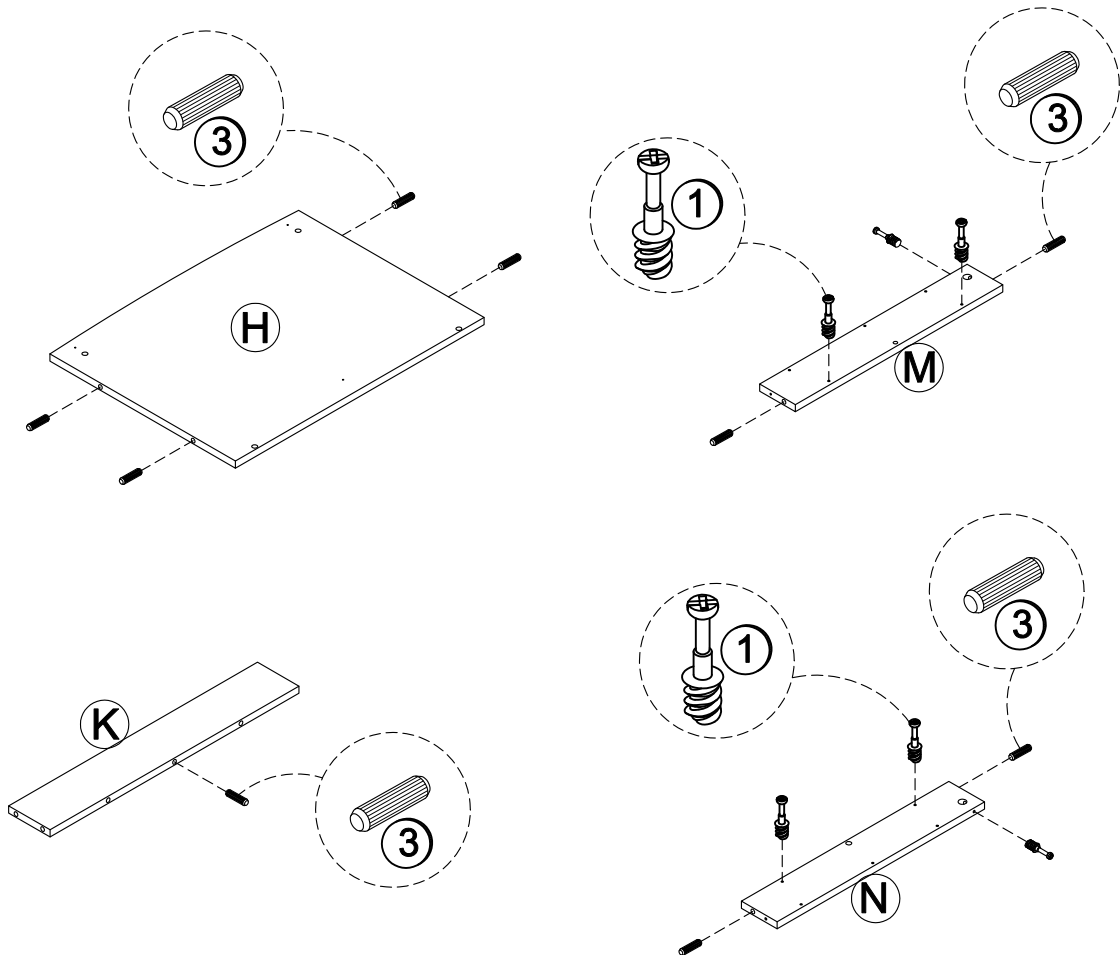

## STEP 3

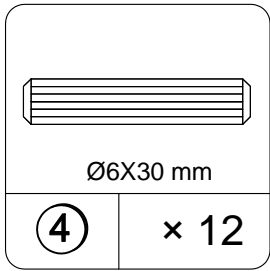

3.1 Insert (4) to (U), (V), (W) & (X) as illustrated.

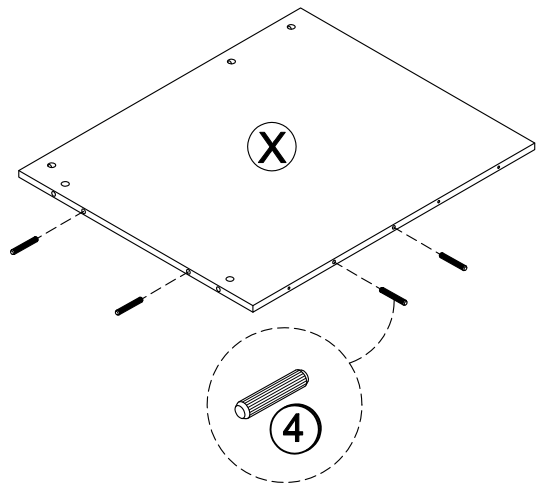
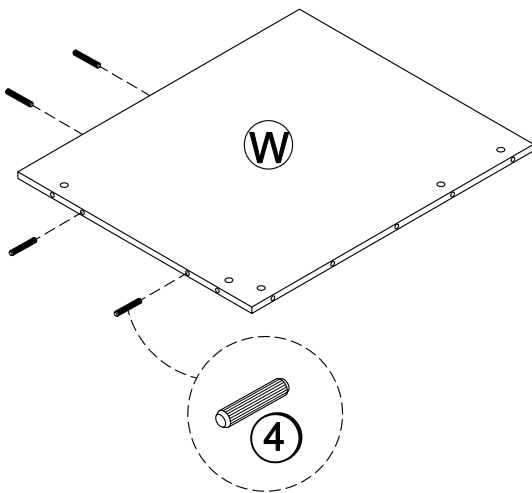
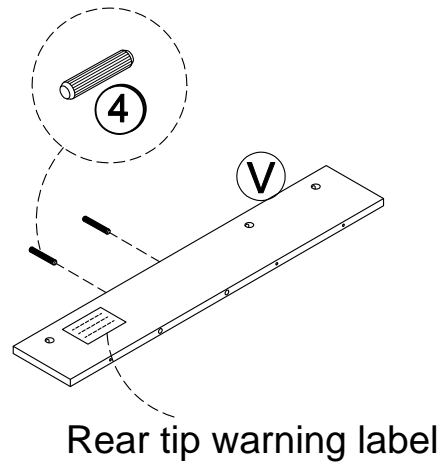
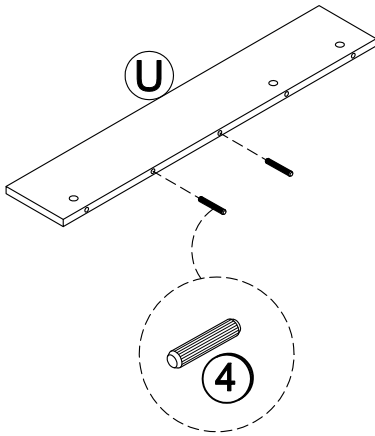

## STEP 4

<p>M8X20 mm</p>		<p>Ø8X30 mm</p>		<p>Ø4X14 mm</p>		<p>Ø35 mm</p>	
①	× 8	③	× 18	⑦	× 16	⑮	× 4

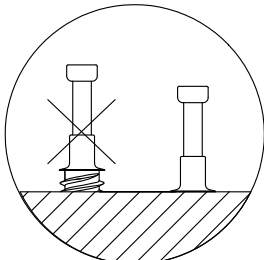

- 4.1 Attach (1) to (Q), (R), (T) & (S) as illustrated.
- 4.2 Insert (3) to (Q), (R), (T) & (S) as illustrated.
- 4.3 Attach (15) to (Q) & (R) with (7) as illustrated.

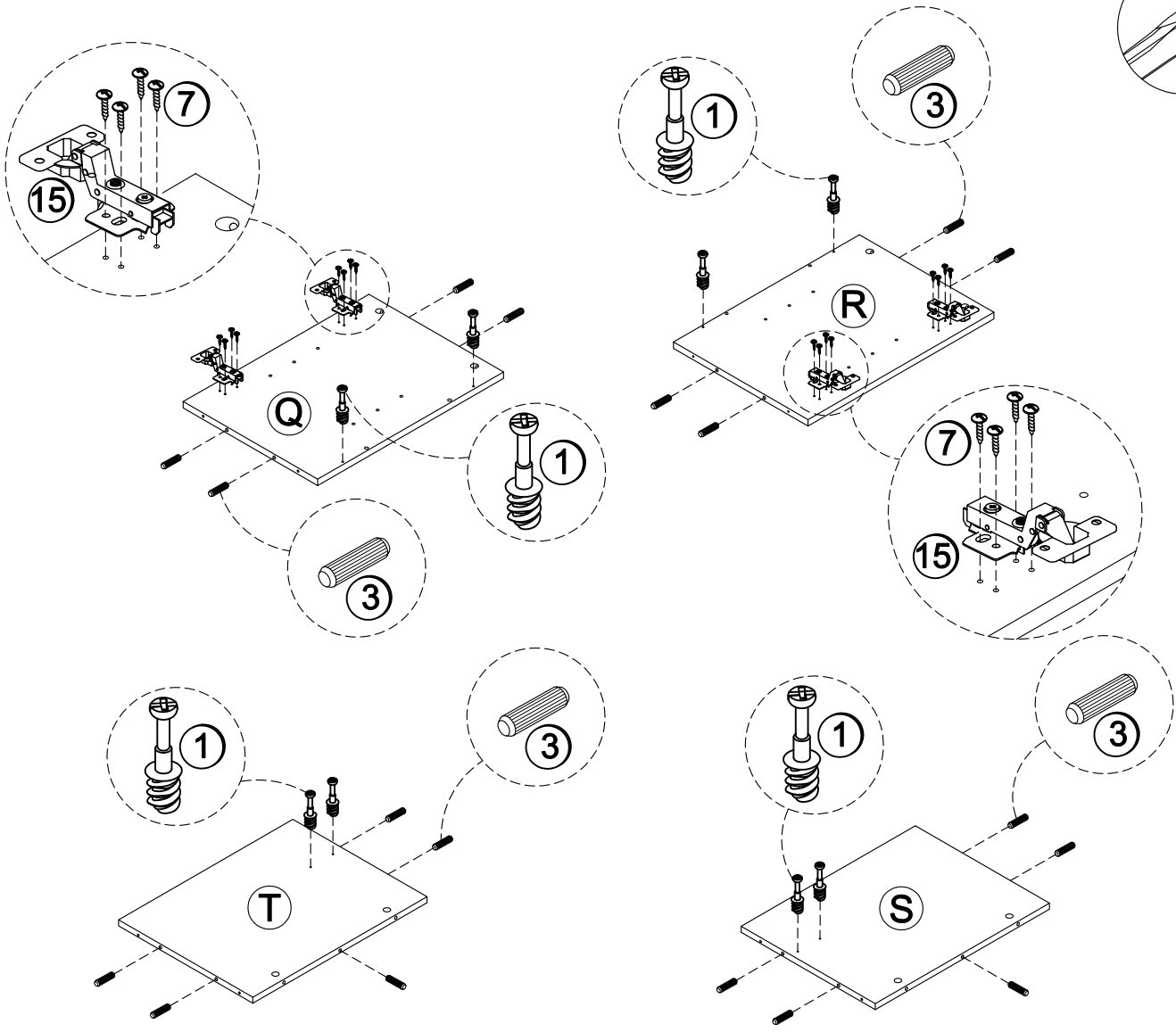
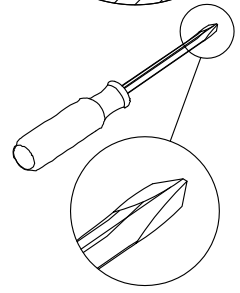

## STEP 5

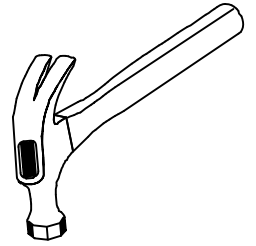
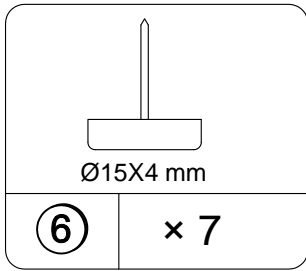

- 5.1 Connect (E), (D) & (F) as illustrated.
- 5.2 Attach (6) to (G), (H) & (I) as illustrated.
- 5.3 Connect (H) to (G) & (I) as illustrated.

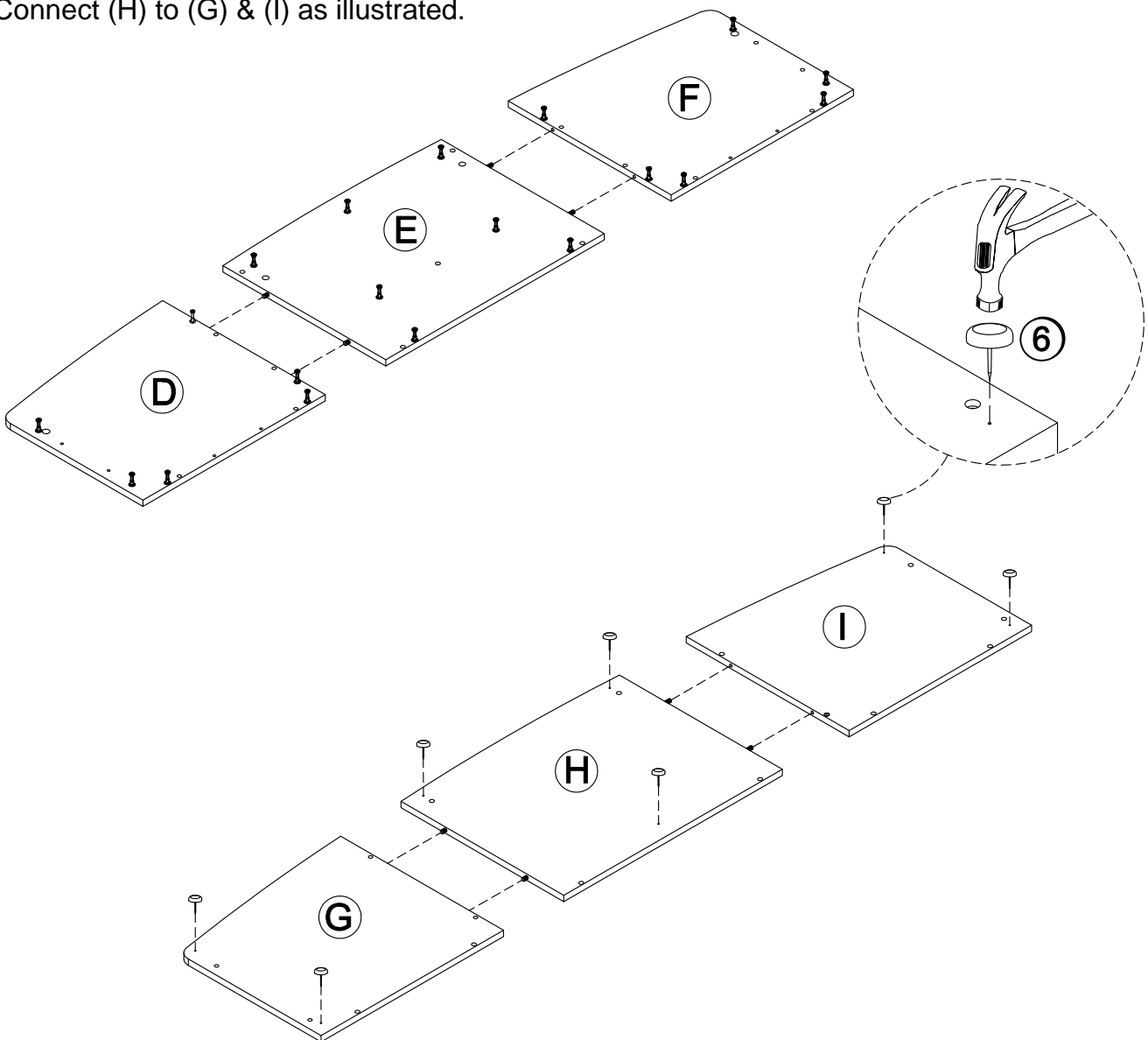

# STEP 6

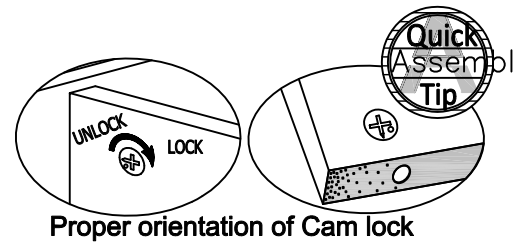
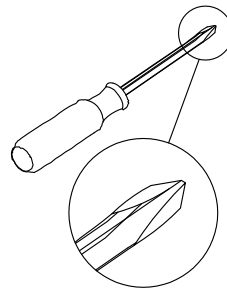
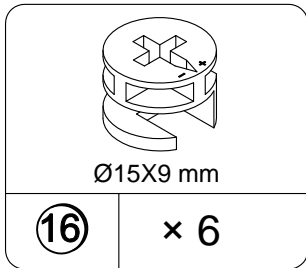

- 6.1 Connect (B) to (A) & (C) as illustrated.
- 6.2 Attach (U) to (A) & (B) with (16) as illustrated.
- 6.3 Attach (V) to (B) & (C) with (16) as illustrated.

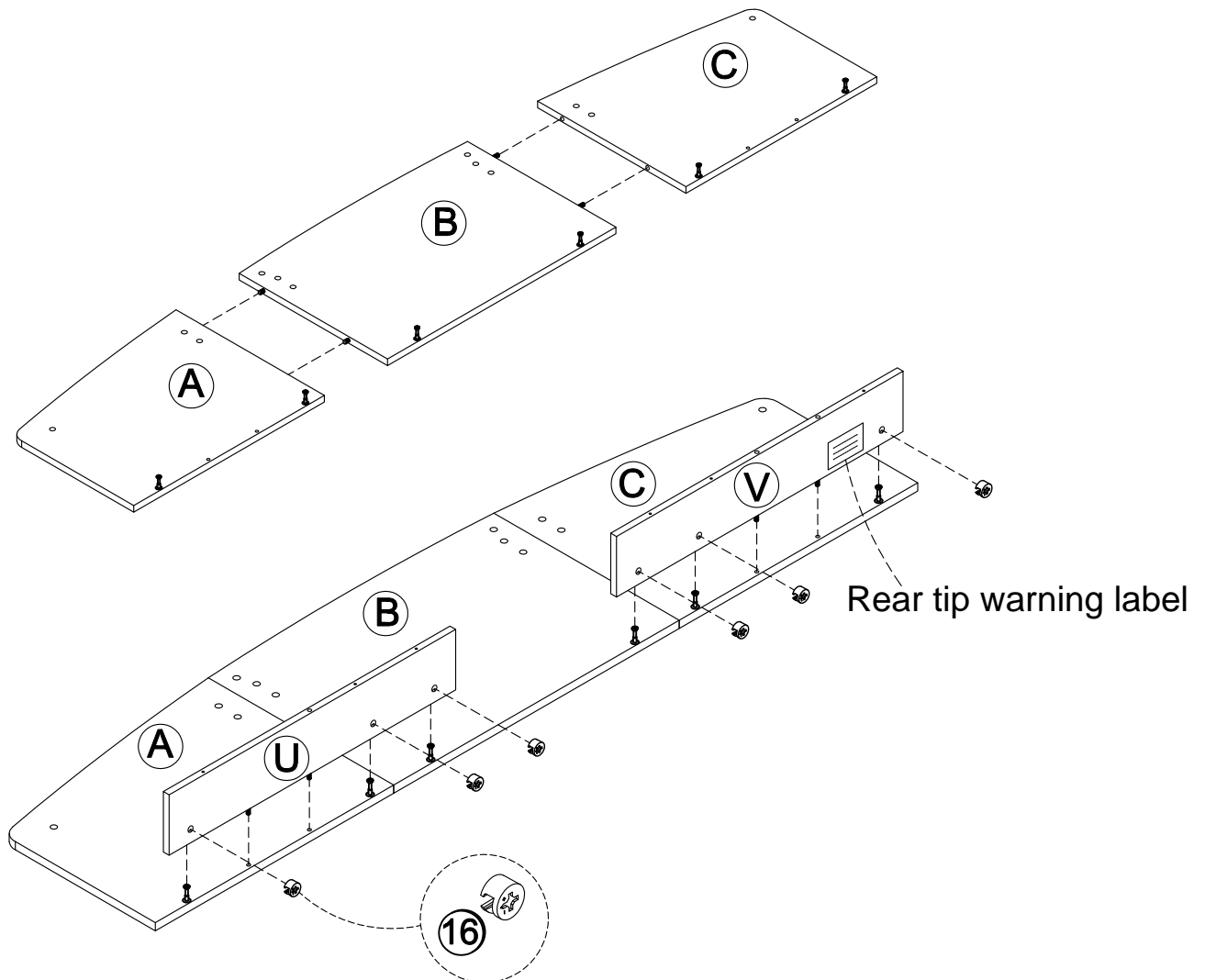

# STEP 7

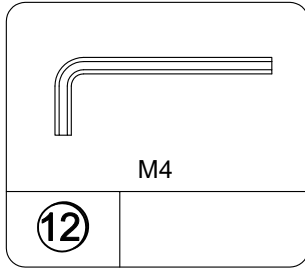
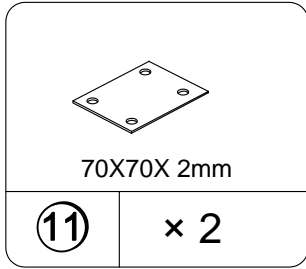
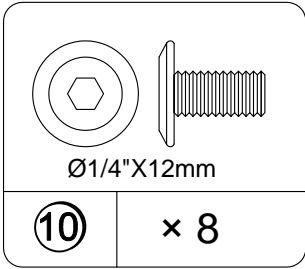

- 7.1 Attach (11) to (A), (B) & (C), with (10) as illustrated.
- 7.2 Attach (Y) to (A), (B) & (C) as illustrated.

**CAUTION: Do not over-tighten support tube to avoid damage the board.**

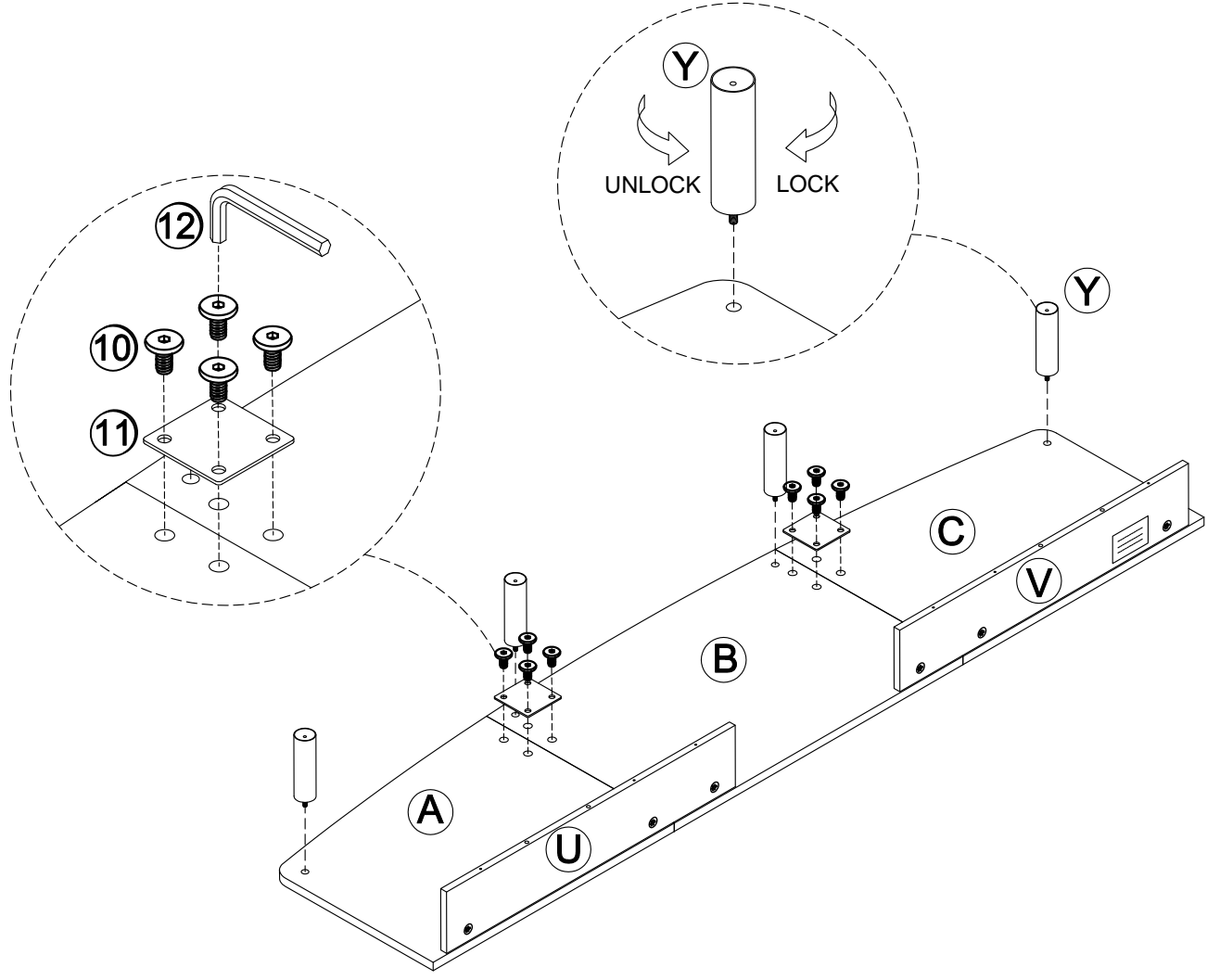



## STEP 8

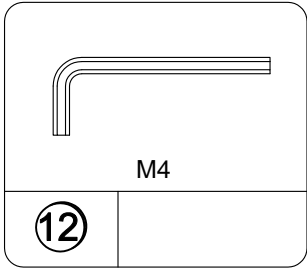
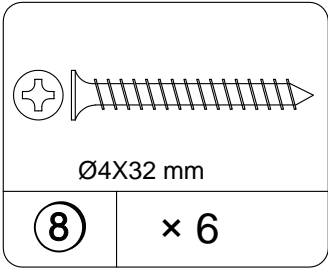
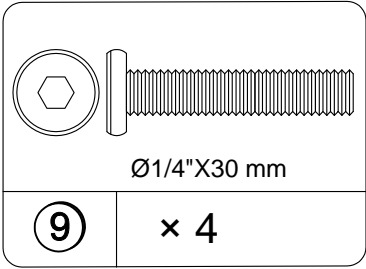
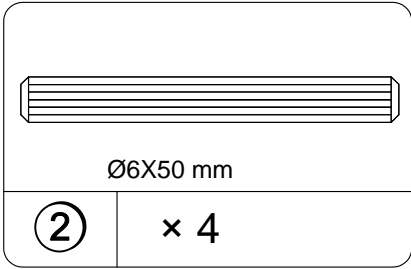

8.1 Insert (2) to (U) & (V) as illustrated.

8.2 Attach (D), (E) & (F) to sample at previous step with (8) & (9) as illustrated.

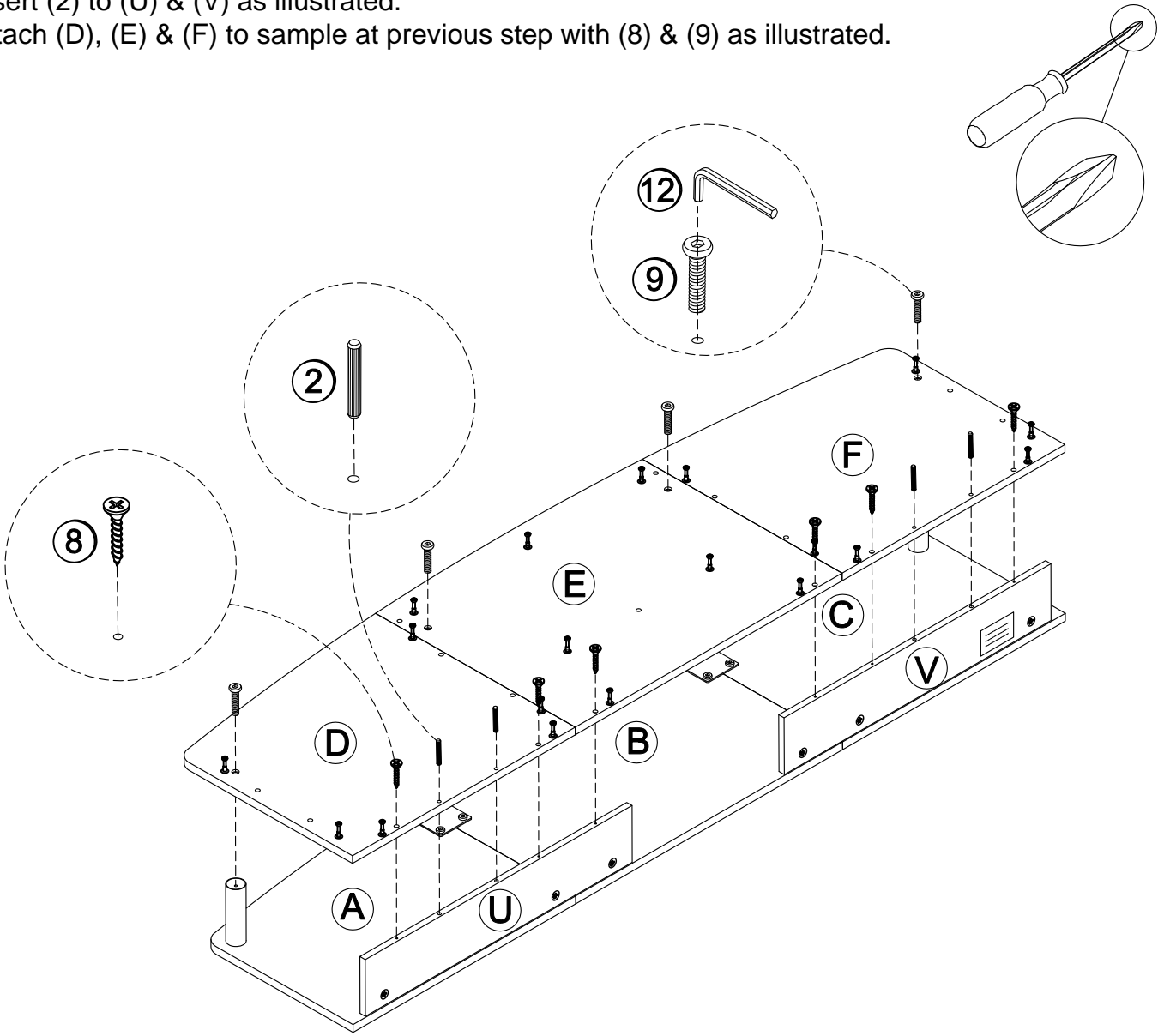

# STEP 9

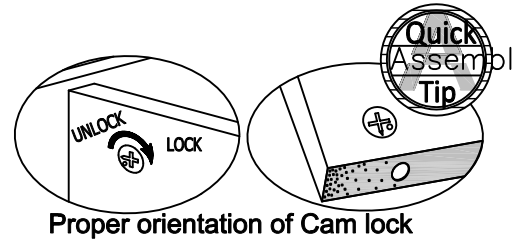
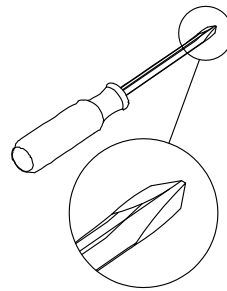
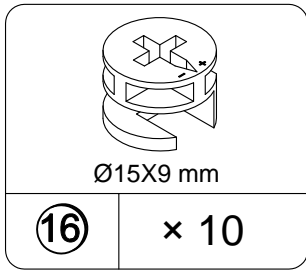

- 9.1 Attach (K) to (T) & (S) with (16) as illustrated.
- 9.2 Attach (L) to (M) & (N) with (16) as illustrated.
- 9.3 Attach (K)-(S)-(T) to (L)-(M)-(N) with (16) as illustrated.

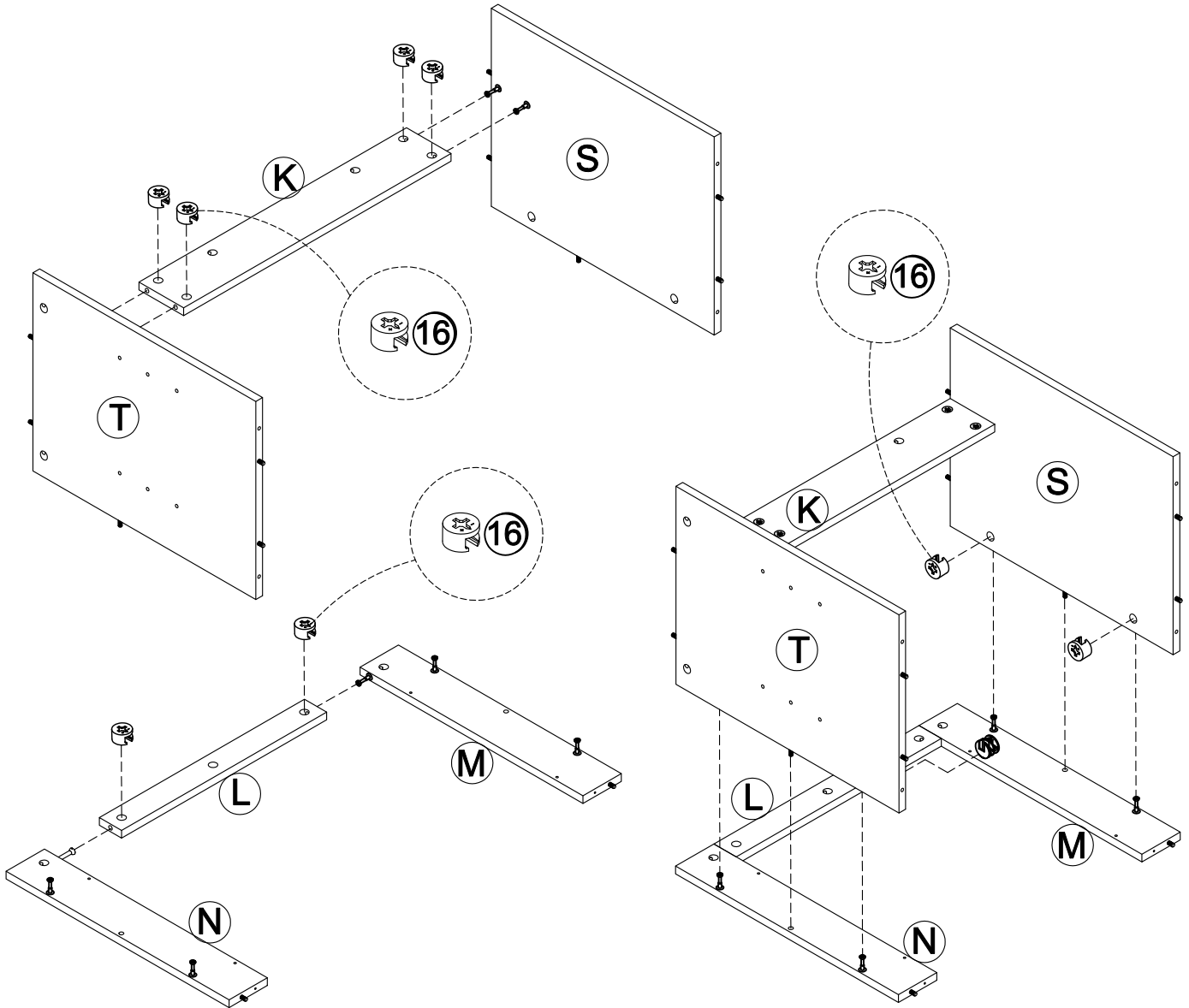

# STEP 10

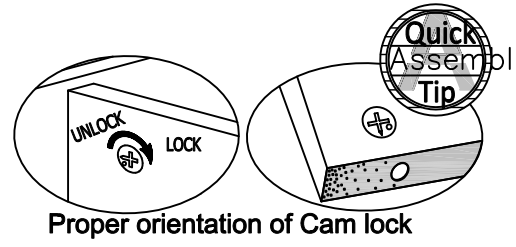
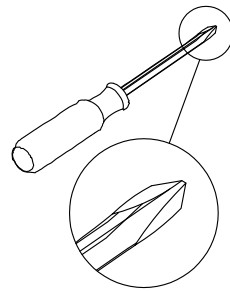
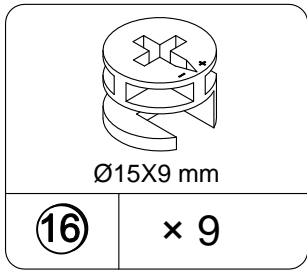

10.1 Attach sample at step (9) to (D), (E) & (F) with (16) as illustrated.

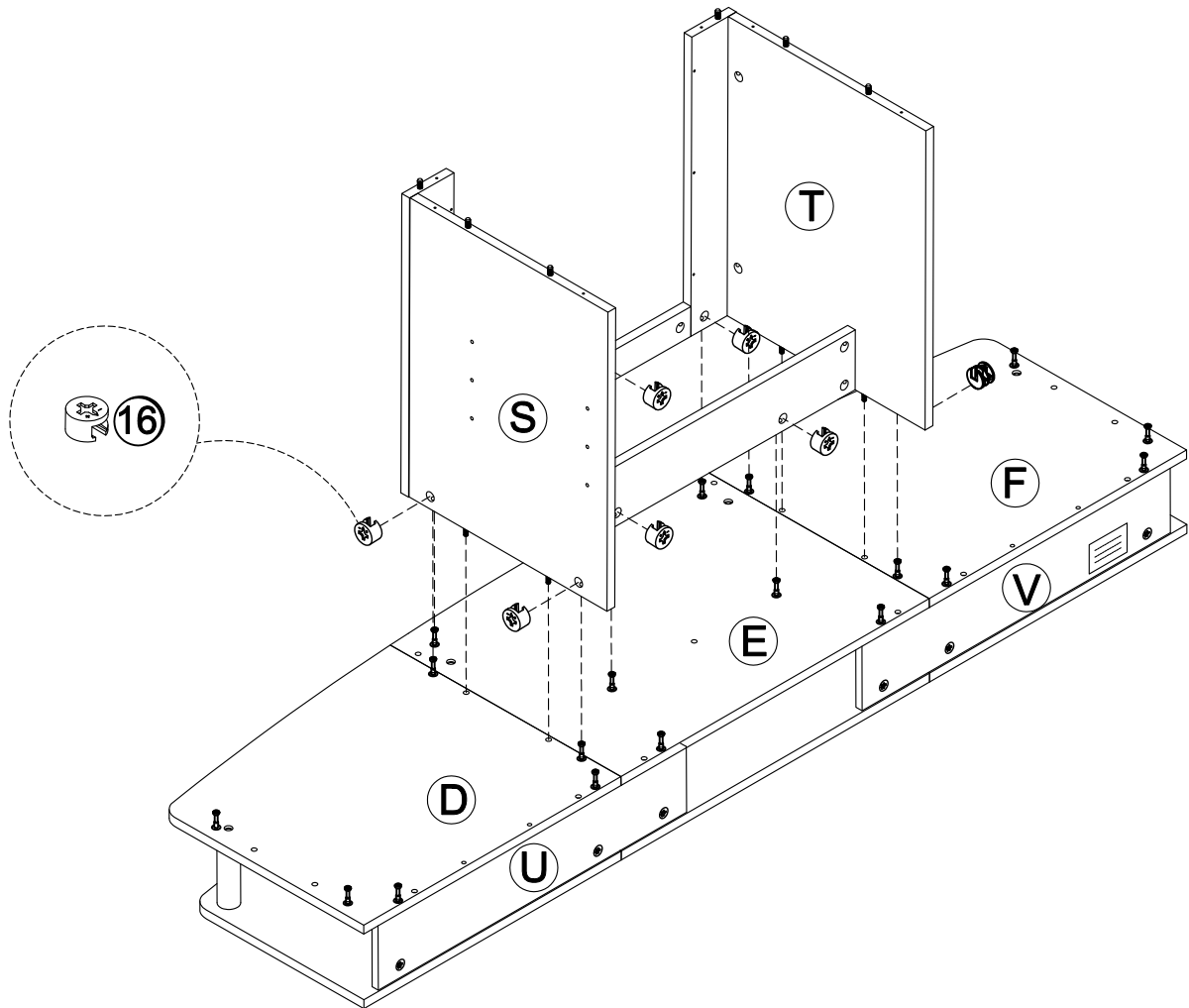

## STEP 11

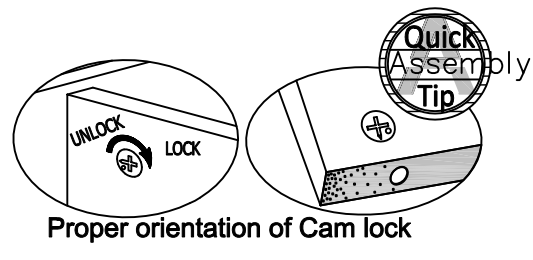
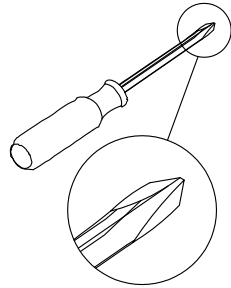
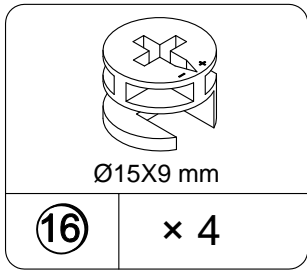

11.1 Attach (W) to (Q); (X) to (R) with (16) as illustrated.

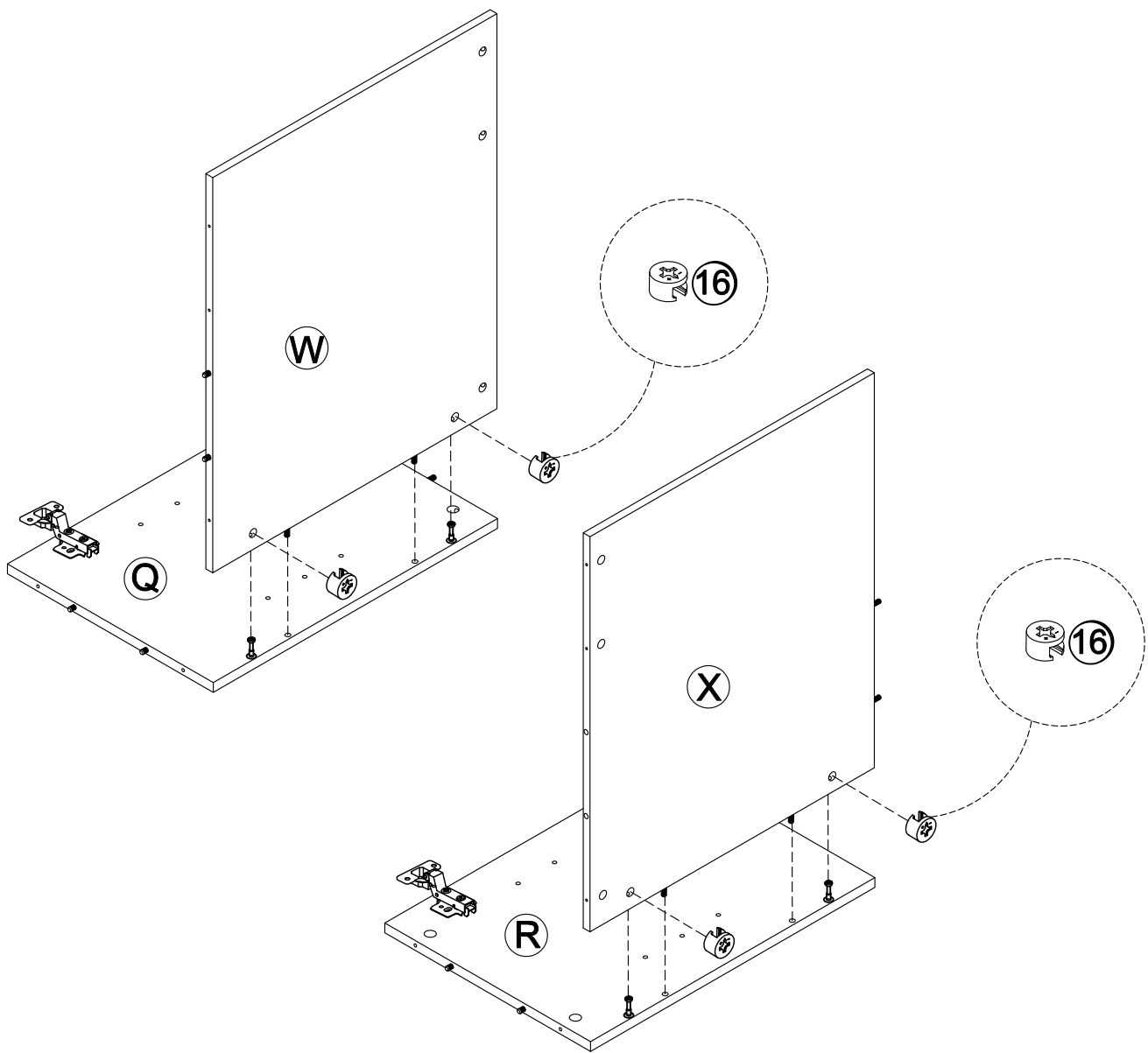

## STEP 12

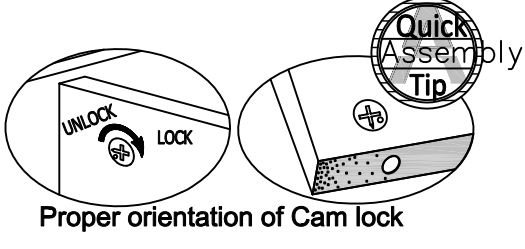
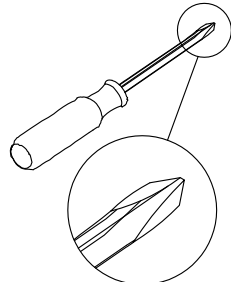
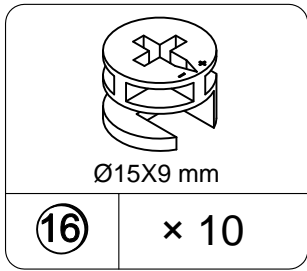

12.1 Attach (Q)-(W) and (R)-(X) to sample at step 10 with (16) as illustrated.

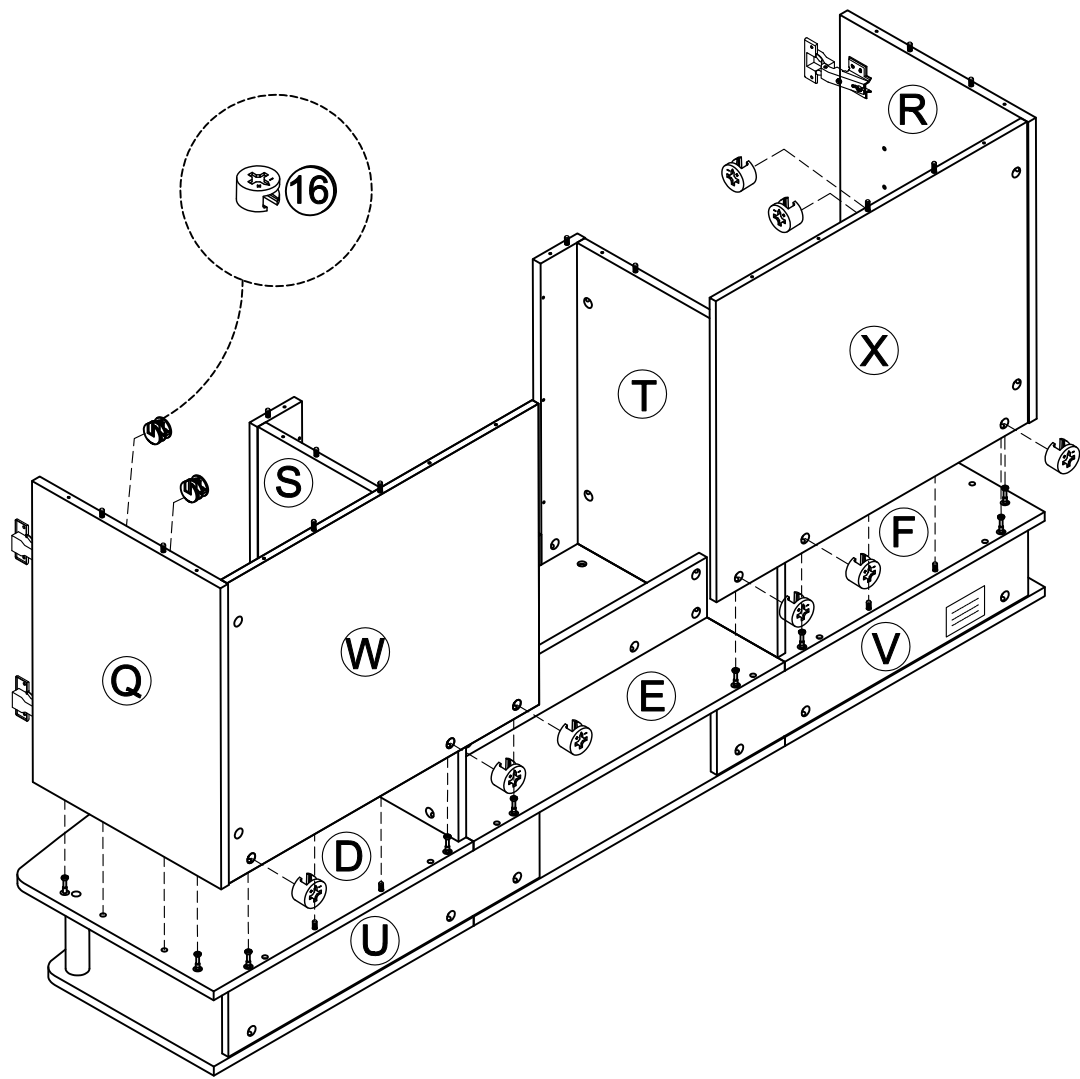

## STEP 13

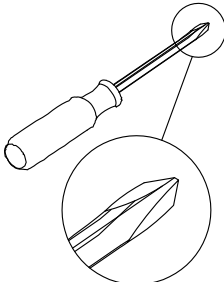
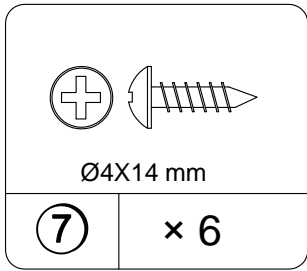

13.1 Attach (Z) to frame with (7) as illustrated.

Note: Please check and tighten all screws in this step

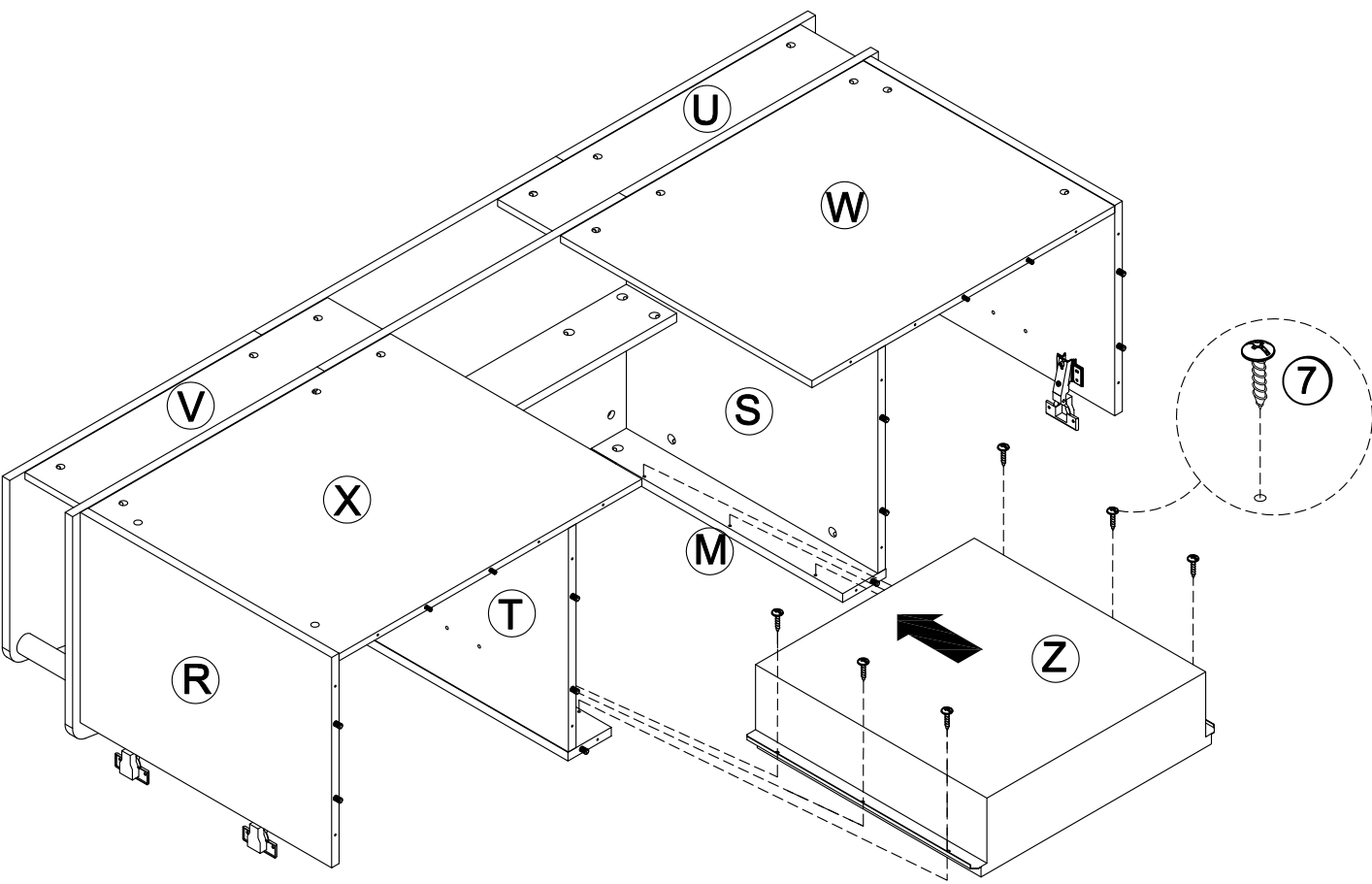

**STEP 14**

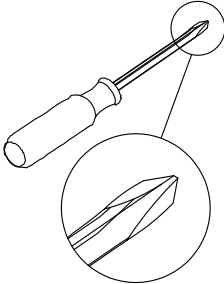
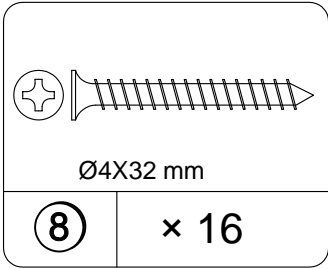

14.1 Attach (G), (H) & (I) to sample from previous step with (8) as illustrated.

Note: Please check and tighten all screws in this step

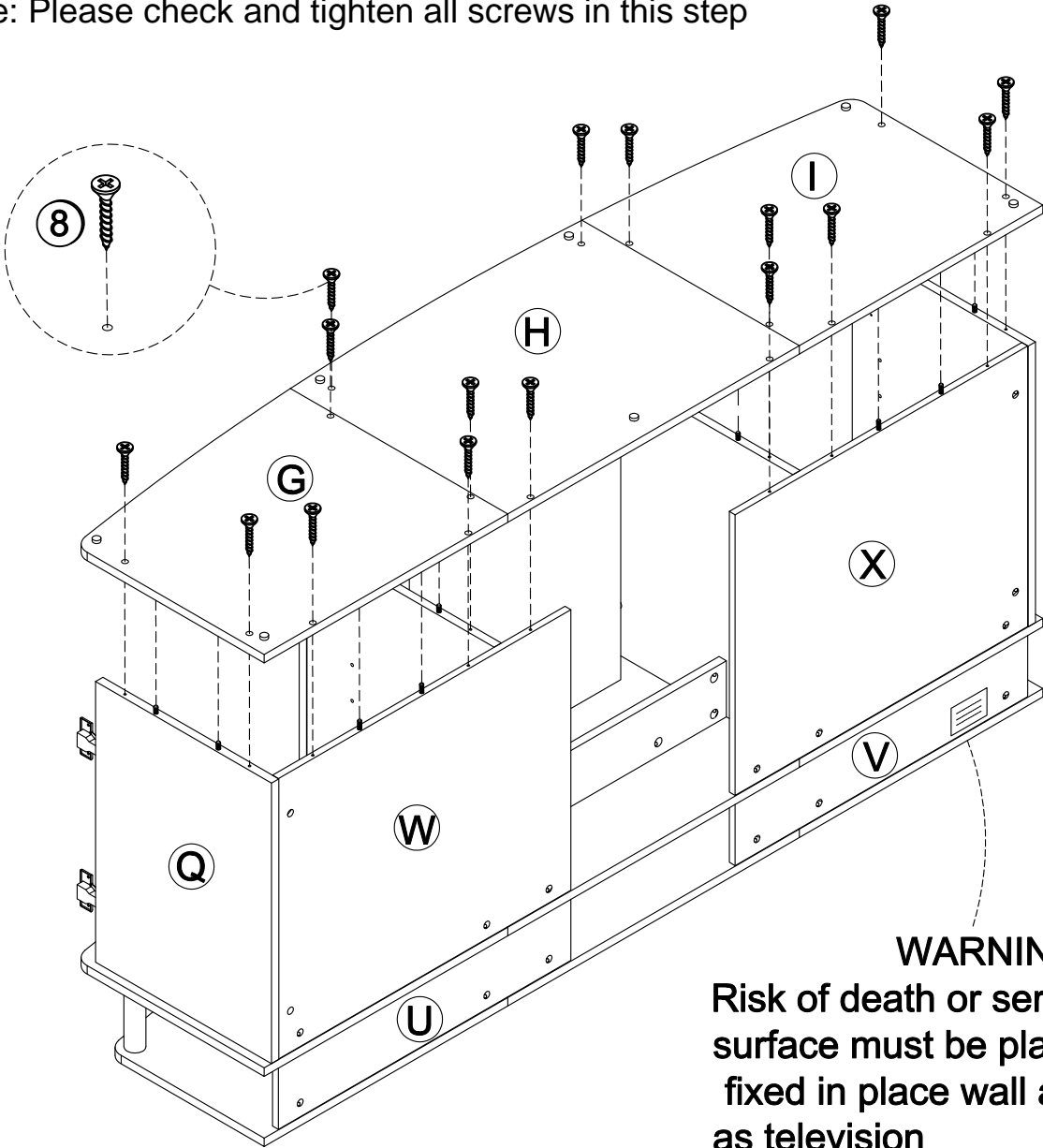

**WARNING**  
Risk of death or serious injury. This surface must be placed against a fixed in place wall at least as tall as television

## STEP 15

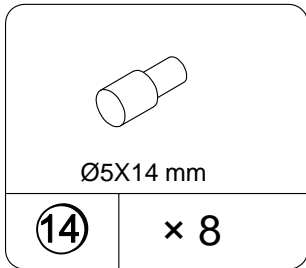

- 15.1 Insert (14) to frame as illustrated.  
 15.2 Put (J) on shelf pin (14) as illustrated.

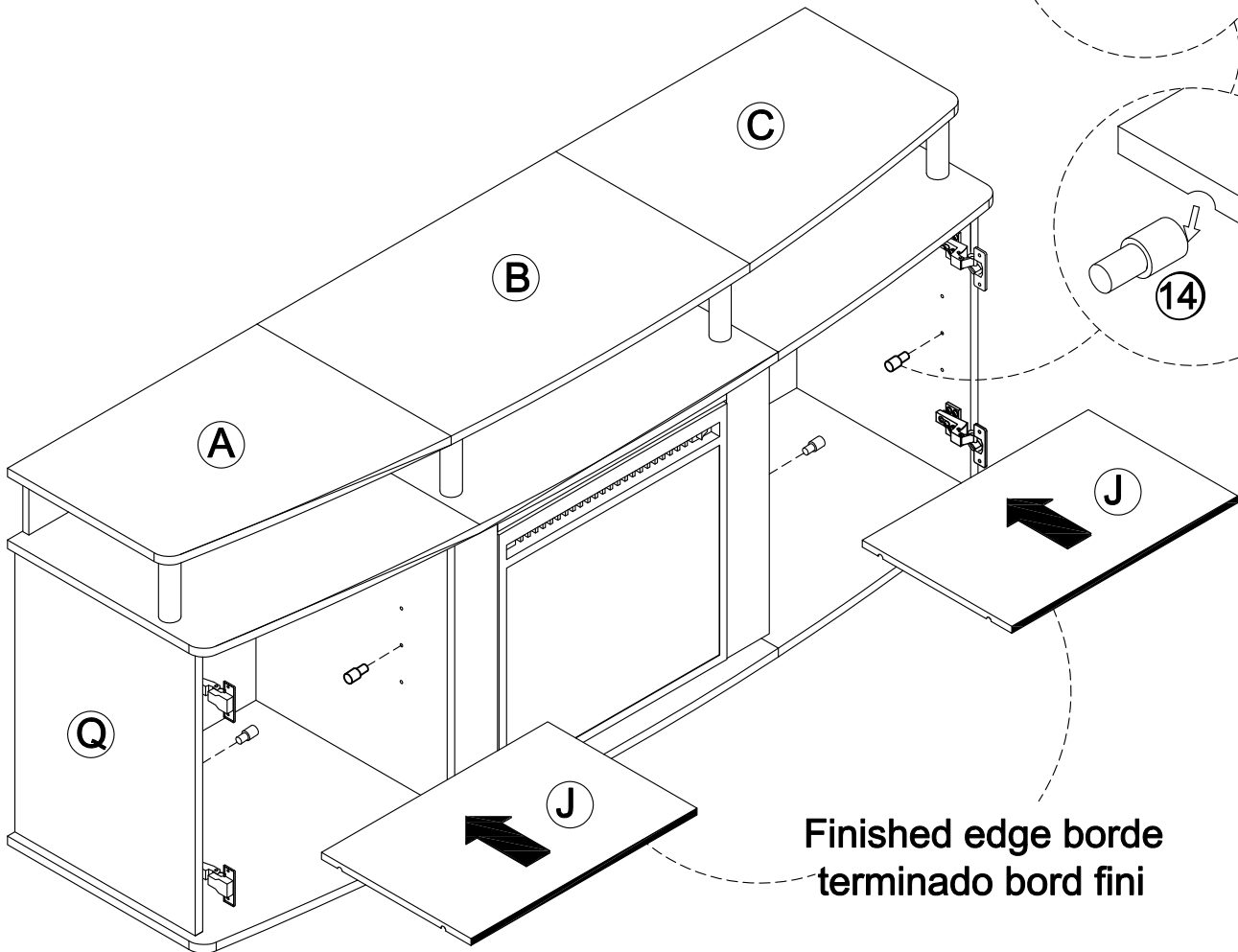
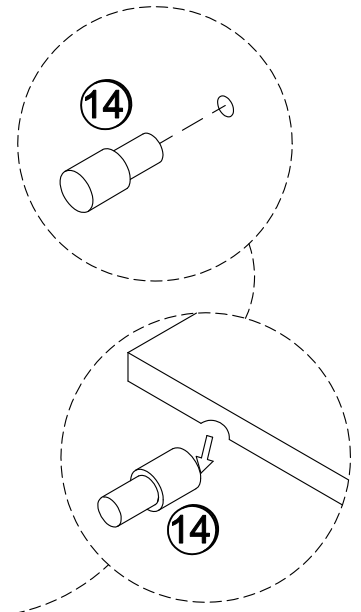
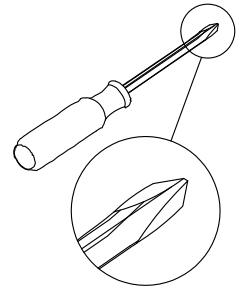



## STEP 16

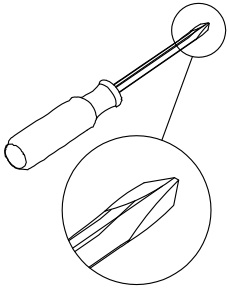
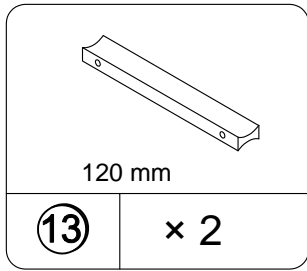
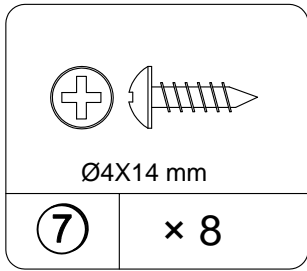
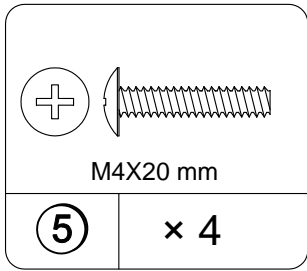

16.1 Attach (O), (P) to sample from previous step with (7) as illustrated.  
 16.2 Attach (13) to (O), (P) with (5) as illustrated.

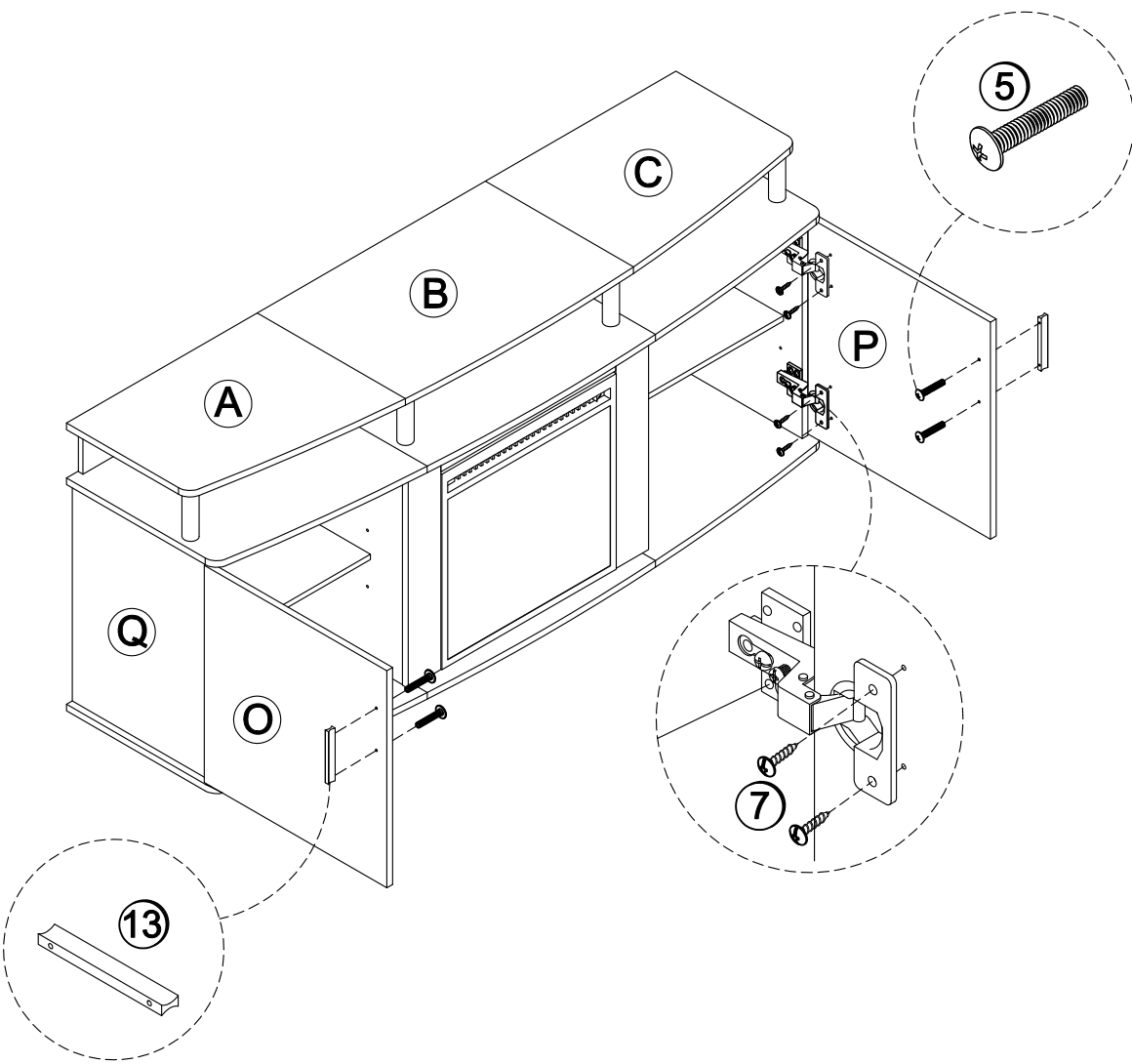

# STEP 17

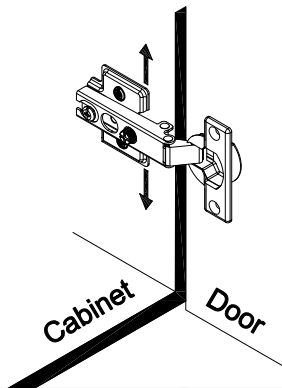
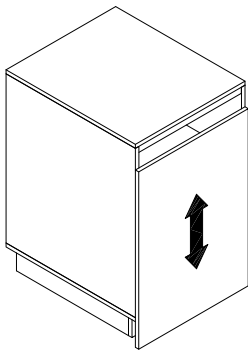
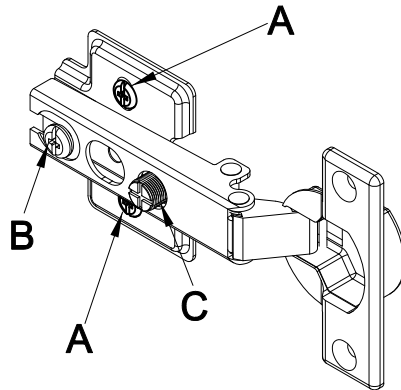

### To adjust the vertical height.

Loosen the four screws "A" on both hinges. Two of them are usually in slotted holes which allows you to adjust up or down by a few mm. Then tighten back up.

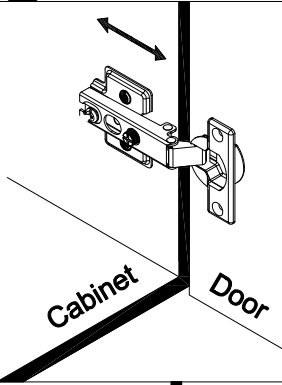
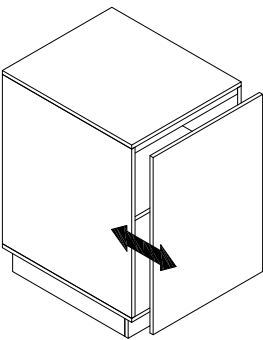

### To adjust depth.

Loosen screw "B" and adjust door, if the door can not be adjusted, please loosen screw "C", then try again. Tighten screw "B" and "C".

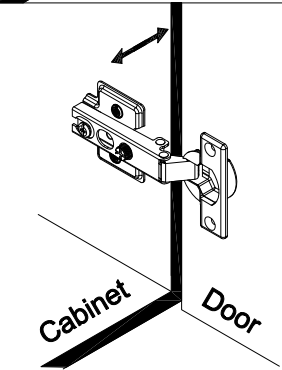
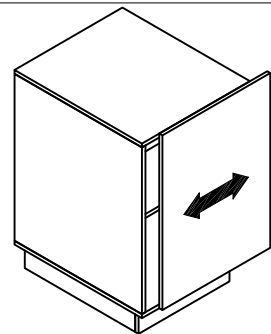

### To adjust side ways.

Turning the screw "C" on BOTH hinges on each door.

## WARNING

If the information in the fireplace operating manual is not followed, an electric shock or fire may result in property damage, personal injury, or loss of life.

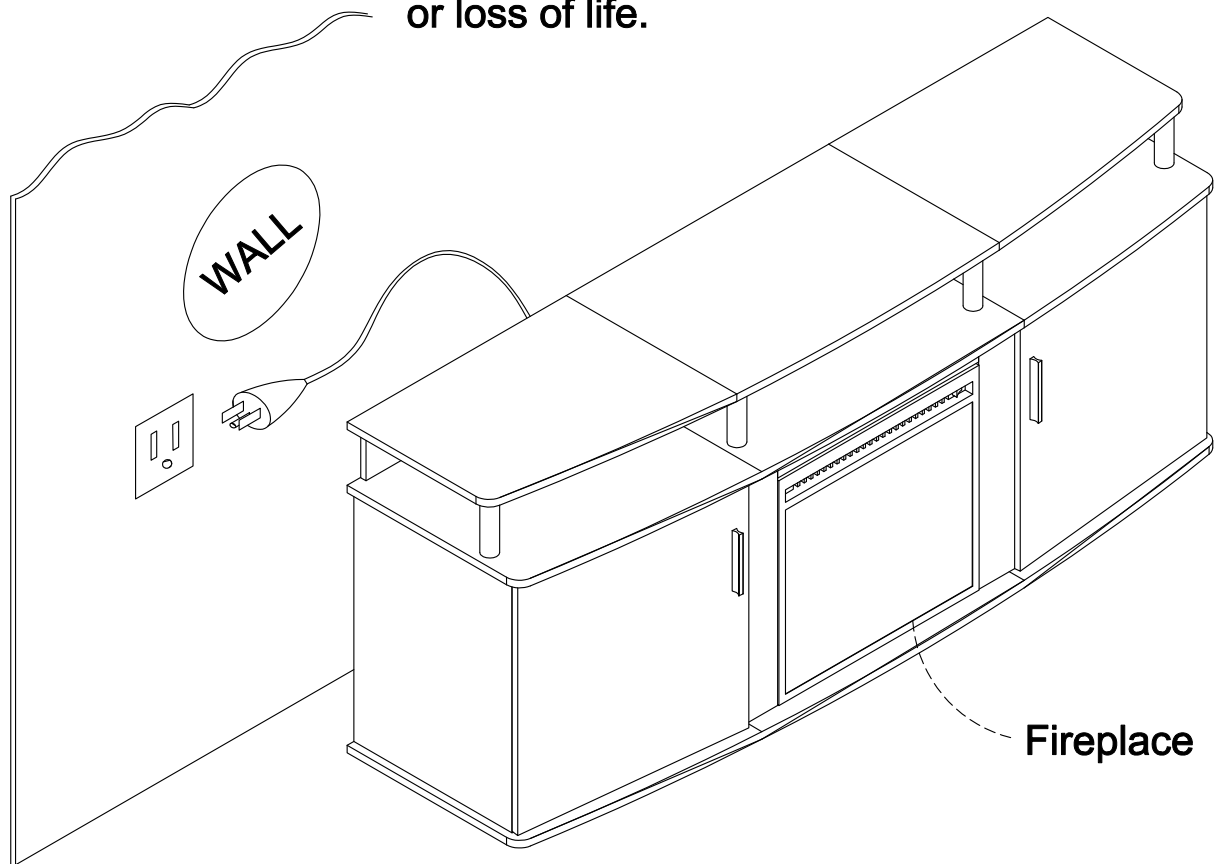

## WARNING

Risk of death or serious injury.  
This unit must be placed against a fixed in place wall at least as tall as television.

## Maximum Loads

This unit has been designed to support the maximum loads shown. Exceeding these load limits could cause sagging, instability, product collapse, and/or serious injury.

Warning: Please apply the TV warning label to your unit so you'll always have the model's weight and TV size limits.

Maximum TV size: 70" flat screen, 120 Lbs/54.5 kgs.

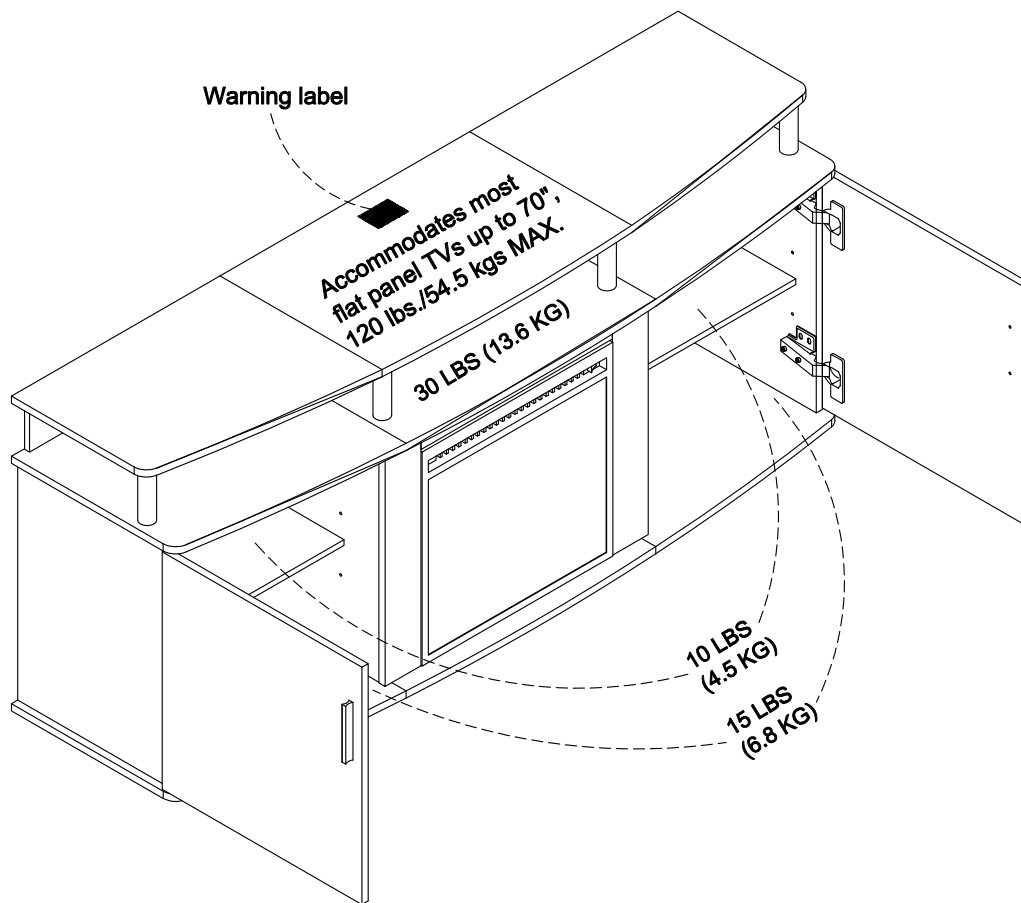

### Certificate of Conformity

1. This certificate applies to the Dorel Home Furnishings, Inc. product identified by this instruction manual.
2. This certificate applies to compliance of this product with the CPSC Ban on Lead-Containing Paint (16 CFR 1303).
3. This product is distributed by: Dorel Home Furnishings, Inc.  
410 East First Street South  
Wright City, MO 63390  
636-745-3351
4. Site of Manufacture: Svay Rieng, Cambodia
5. See front page of instruction manual for date of manufacture.

---

Register your product to receive the following:



- \* New trend details - sneak peek on what's new
- \* Surveys - have a voice within our community
- \* Exclusive deals and discount codes
- \* Quick and easy replacement part service

To register your product, visit [ameriwoodhome.com](http://ameriwoodhome.com)

## *Star Rating*



Visit your local retailer's website, rate your purchased product and leave us some feedback!

We would like to extend a big "Thank You" to all of our customers for taking the time to assemble this Ameriwood Home product, and to give us your valuable feedback.

*Thank  
You!*

## Cubierta Delantera

Este libro de instrucciones contiene información **IMPORTANTE** de seguridad. Por favor lea y manténgalo para referencia en el futuro.

**No Regrese este producto!** Comuníquese con nuestro amigoso equipo de servicio al cliente para obtener ayuda.

Llámenos al: 1-800-489-3351 (Gratis) Lunes - Viernes 9am - 5pm CST

Visitar: [www.ameriwoodhome.com](http://www.ameriwoodhome.com)

## PRECAUCION

Este mueble puede volcarse y causar graves heridas y/o muerte.

Anclar el mueble a un poste de madera en la pared (si esto se requiere).

No Permita que los niños monten el mueble.

Mantenga los artículos más pesados en los cajones de abajo.

## Consejos Útiles (página 2)

- Abra su artículo en el área donde usted planea utilizarlo para evitar levantar y moverlo menos
- Identificar, ordenar y contar las piezas antes de intentar ensamblar
- Las clavijas de compresión se golpean con un martillo
- Las diapositivas están marcadas con una R (derecha) y L (izquierda) para la colocación correcta
- Asegúrese de que siempre este el punto localizado en la parte superior de bloqueador de leva este volteado hacia borde exterior
- Utilizar todos los clavos para el panel de atrás y distribuirlos por igual
- El panel de atrás debe utilizarse para asegurarse de que la unidad quede fija y firme
- No use químicas fuertes ni limpiadores abrasivos en este artículo
- Nunca empuje, tire ni arrastre los muebles

## Antes de Que Empieces (página 3)

- Lea cuidadosamente cada paso y siga el orden correcto

- Separar y contar todas sus piezas y hardware

- Dése suficiente espacio para el proceso de ensamble

- Tenga las siguientes herramientas: destornillador de cabeza plana, #2 cabeza Phillips

Destornillador y martillo

- Precaución: Si usa un taladro electrónico o un destornillador eléctrico para atornillar, por favor asegúrese que deje de atornillar cuando el tornillo este apretado. Fallar hacer esto puede causar barrer el tornillo.

## Sistema de fijar el bloqueo de leva (página 3)

Este sistema de fijar el bloqueo de leva sera usado en todo el proceso ensamble.

## Identificación de los Paneles (Página 4-7)

Este no es el tamaño real

- (A) ARRIBA IZQUIERDA
- (B) PARTE MEDIA
- (C) ARRIBA DERECHA
- (D) ESTANTE IZQUIERDO
- (E) ESTANTE MEDIO
- (F) ESTANTE DERECHO
- (G) INFERIOR IZQUIERDA
- (H) PARTE INFERIOR MEDIA
- (I) INFERIOR DERECHA
- (J) ESTANTE AJUSTABLE
- (K) PANEL DE SOPORTE
- (L) DELANTAL SUPERIOR
- (M) DELANTAL IZQUIERDO
- (N) DELANTAL DERECHO
- (O) PUERTA IZQUIERDA
- (P) PUERTA DERECHA
- (Q) PANEL LATERAL IZQUIERDO
- (R) PANEL LATERAL DERECHO
- (S) PARICIÓN IZQUIERDA
- (T) PARTICIÓN DERECHA
- (U) PANEL TRASERO SUPERIOR IZQUIERDO
- (V) PANEL TRASERO SUPERIOR DERECHO
- (W) PANEL TRASERO INFERIOR IZQUIERDO
- (X) PANEL TRASERO INFERIOR DERECHO
- (Y) TUBO DE SOPORTE
- (Z) INSERTO PARA CHIMENEA

## Lista de Piezas (Página 8)

Tamaño real

- (1) Perno de leva
- (2) Pasador de madera
- (3) Pasador de madera
- (4) Pasador de madera
- (5) Perno
- (6) Planeo de virada
- (7) Tornillo
- (8) Tornillo
- (9) Perno
- (10) Perno

## Lista de Piezas (Página 9)

Este no es el tamaño real

- (11) Placa de metal
- (12) Llave hexagonal
- (13) Mango
- (14) Pasador de soporte
- (15) Bisagra europea
- (16) Bloqueo de leva
- (17) Etiqueta de advertencia

## Página 10

1.1 Adjunte (1) a (A), (B), (C), (D), (E) y (F) como se ilustra.

1.2 Inserte (3) en (B) y (E) como se ilustra.

## Página 11

2.1 Conecte (1) a (M) y (N) como se ilustra.

2.2 Inserte (3) en (H), (K), (M) y (N) como se ilustra.

## Página 12

3.1 Inserte (4) en (U), (V), (W) y (X) como se ilustra.

## Página 13

4.1 Conecte (1) a (Q), (R), (T) y (S) como se ilustra.

4.2 Inserte (3) en (Q), (R), (T) y (S) como se ilustra.

4.3 Conecte (15) a (Q) y (R) con (7) como se ilustra.

## Página 14

5.1 Conecte (E), (D) y (F) como se ilustra.

5.2 Conecte (6) a (G), (H) e (I) como se ilustra.

5.3 Conecte (H) a (G) e (I) como se ilustra.

## **Página 15**

- 6.1 Conecte (B) a (A) y (C) como se ilustra.
- 6.2 Conecte (U) a (A) y (B) con (16) como se ilustra.
- 6.3 Conecte (V) a (B) y (C) con (16) como se ilustra.

## **Página 16**

- 7.1 Conecte (11) a (A), (B) y (C), con (10) como se ilustra.
- 7.2 Conecte (Y) a (A), (B) y (C) como se ilustra.

PRECAUCIÓN: No apriete demasiado el tubo de soporte para evitar dañar la placa.

## **Página 17**

- 8.1 Inserte (2) en (U) y (V) como se ilustra.
- 8.2 Conecte (D), (E) y (F) a la muestra en el paso anterior con (8) y (9) como se ilustra.

## **Página 18**

- 9.1 Conecte (K) a (T) y (S) con (16) como se ilustra.
- 9.2 Conecte (L) a (M) y (N) con (16) como se ilustra.
- 9.3 Conecte (K) - (S) - (T) a (L) - (M) - (N) con (16) como se ilustra.

## **Página 19**

- 10.1 Adjunte la muestra en el paso (9) a (D), (E) y (F) con (16) como se ilustra.

## **Página 20**

- 11.1 Adjuntar (W) a (Q); (X) a (R) con (16) como se ilustra.

## **Página 21**

- 12.1 Adjunte (Q) - (W) y (R) - (X) a la muestra en el paso 10 con (16) como se ilustra.

## **Página 22**

- 13.1 Fije (Z) al marco con (7) como se ilustra.

Nota: Verifique y apriete todos los tornillos en este paso.

## **Página 23**

- 14.1 Adjunte (G), (H) e (I) a la muestra del paso anterior con (8) como se ilustra.

Nota: Verifique y apriete todos los tornillos en este paso.

ADVERTENCIA: Riesgo de muerte o lesiones graves. Esta superficie debe colocarse contra una pared fija al menos tan alta como un televisor.

## **Página 24**

- 15.1 Inserte (14) en el marco como se ilustra.
- 15.2 Coloque (J) en el pasador del estante (14) como se ilustra.

## **Página 25**

- 16.1 Adjunte (O), (P) a la muestra del paso anterior con (7) como se ilustra.
- 16.2 Conecte (13) a (O), (P) con (5) como se ilustra.

## **Página 26**

Instrucción de ajuste de la bisagra de la puerta



## **Página 27**

### **ADVERTENCIA DE SEGURIDAD PARA CHIMENEAS:**

Si no se sigue la información del manual de funcionamiento de firepalce, una descarga eléctrica o un incendio pueden provocar daños a la propiedad, lesiones personales o la muerte.

### **RIESGO DE PROPINAS:**

Riesgo de muerte o lesiones graves. Esta unidad debe colocarse contra una pared fija al menos tan alta como un televisor.

## **Página 28**

### **CARGA MAXIMA**

Esta unidad ha sido diseñada para soportar la carga máxima anotada. El exceder estos límites puede causar inestabilidad, colapsarse y/o causar serias lesiones.

**ADVERTENCIA:** aplique la etiqueta de advertencia de TV a su unidad para que siempre tenga los límites de peso y tamaño de TV del modelo.

Tamaño máximo del televisor: pantalla plana de 70 ", 120 libras / 54,5 kg.

## **Página 29**

Registre su producto para recibir lo siguiente:

- \* Detalles de nuevas tendencias - Vistazo a lo nuevo
- \* Encuestas - aloc su voz entre su comunidad
- \* Códigos de ofertas y descuentos exclusivos
- \* Fácil y rápido servicio de partes de remplace

Para registrar su producto, visite [ameriwoodhome.com](http://ameriwoodhome.com)

Clasificación de 5 estrellas

Visite el sitio web de su distribuidor local, califique el producto que compró y déjenos sus comentarios.

Nos gustaría enviar un gran "Agradecimiento" a todos nuestros clientes por tomarse el tiempo de ensamblar este producto de Ameriwood Home, y por darnos sus valiosos comentarios.

Gracias

## Couverture Avant

CE LIVRET D'INSTRUCTION CONTIENT DES INFORMATIONS **IMPORTANTES** SUR LA SÉCURITÉ. VEUILLEZ LIRE ET GARDER POUR UNE RÉFÉRENCE FUTURE

**Ne retournez pas ce produit!** Contactez notre équipe de service à la clientèle amicale d'abord pour obtenir de l'aide.

**Appelez-nous:** 1-800-489-3351 (sans frais) du Lundi au Vendredi de 9h à 17h Heure Centrale

**Visitez:** [www.ameriwoodhome.com](http://www.ameriwoodhome.com)

## ATTENTION

Le meuble peut basculer et causer des blessures graves ou la mort.

Ancrer le meuble à une planche murale dans le mur (si indiqué).

Ne laissez pas les enfants grimper sur le meuble.

Placez les articles lourds sur les étagères ou dans les tiroirs inférieurs.

## Astuces Utiles (page 2)

-Ouvrez votre article dans la zone que vous prévoyez de le garder pour moins de levage lourd

-Identifier, trier et compter les pièces avant d'essayer d'assembler

-Les goujons de compression sont taraudés avec un Marteau

-Les glissières sont marquées d'un R (droit) et d'un L (gauche) pour un bon placement

-Assurez-vous toujours de faire face la pointe situé sur le haut de la Serrure de Came vers le bord extérieur

-Utiliser tous les clous fournis pour le panneau arrière et les répartir également

-Le panneau arrière doit être utilisé pour vous assurer que votre appareil est robuste

-N'utilisez pas de produits chimiques agressifs ou de nettoyeurs abrasifs sur cet appareil

-Ne jamais pousser, tirer, ou faire glisser votre meuble

## Avant de Commencer (page 3)

-Lisez attentivement chaque étape et suivez le bon ordre

-Séparez et comptez toutes vos pièces et matériaux

-Donnez-vous suffisamment de place pour l'assemblage

-Avoir les outils suivants: tournevis à tête plate, #2 tournevis Phillips, et Marteau

-Attention: Si vous utilisez une perceuse électrique ou un tournevis électrique pour visser, veillez à ralentir et arrêter lorsque la vis est bien serrée. Le non-respect de cette consigne peut endommager la vis.

## Système de Fixation de Came (page 3)

Ce Système de Fixation de Came sera utilisé tout au long de l'assemblage

## Identification des matériaux (Page 4-7)

Pas de taille réelle

- (A) EN HAUT À GAUCHE
- (B) HAUT DU MILIEU
- (C) HAUT DROIT
- (D) ÉTAGÈRE GAUCHE
- (E) ÉTAGÈRE DU MILIEU
- (F) ÉTAGÈRE DE DROITE
- (G) EN BAS À GAUCHE
- (H) MILIEU EN BAS
- (I) EN BAS À DROITE
- (J) TABLETTE AJUSTABLE
- (K) PANNEAU DE SOUTIEN
- (L) TABLIER SUPÉRIEUR
- (M) TABLIER GAUCHE
- (N) TABLIER DROIT
- (O) PORTE GAUCHE
- (P) PORTE DROITE
- (Q) PANNEAU LATÉRAL GAUCHE
- (R) PANNEAU CTÉ DROIT
- (S) PAROIS GAUCHE
- (T) CLOISON DROITE
- (U) PANNEAU SUPÉRIEUR ARRIÈRE GAUCHE
- (V) PANNEAU SUPÉRIEUR ARRIÈRE DROIT
- (W) PANNEAU DORSAL INFÉRIEUR GAUCHE
- (X) PANNEAU INFÉRIEUR DORSAL DROIT
- (Y) TUBE DE SUPPORT
- (Z) ENCASTRABLE DE FOYER

## Liste des pièces (Page 8)

Taille réelle

- (1) Boulon à came
- (2) Cheville en bois
- (3) Cheville en bois
- (4) Cheville en bois
- (5) Boulon
- (6) glisse d'amure
- (7) Vis
- (8) Vis
- (9) Boulon
- (10) Boulon

## Liste des pièces (Page 9)

Pas de taille réelle

- (11) Plaque de métal
- (12) Clé hexagonale
- (13) Poignée
- (14) Goupille de support
- (15) Euro charnière
- (16) Serrure à came
- (17) Étiquette d'avertissement

## Page 10

- 1.1 Attachez (1) à (A), (B), (C), (D), (E) et (F) comme illustré.
- 1.2 Insérez (3) à (B) et (E) comme illustré.

## Page 11

- 2.1 Fixez (1) à (M) et (N) comme illustré.
- 2.2 Insérez (3) à (H), (K), (M) et (N) comme illustré.

## Page 12

- 3.1 Insérez (4) à (U), (V), (W) et (X) comme illustré.

## Page 13

- 4.1 Attachez (1) à (Q), (R), (T) et (S) comme illustré.
- 4.2 Insérez (3) à (Q), (R), (T) et (S) comme illustré.
- 4.3 Fixez (15) à (Q) et (R) avec (7) comme illustré.

## Page 14

- 5.1 Connectez (E), (D) et (F) comme illustré.
- 5.2 Fixez (6) à (G), (H) et (I) comme illustré.
- 5.3 Connectez (H) à (G) et (I) comme illustré.

## Page 15

- 6.1 Connectez (B) à (A) et (C) comme illustré.
- 6.2 Fixez (U) à (A) et (B) avec (16) comme illustré.
- 6.3 Fixez (V) à (B) et (C) avec (16) comme illustré.

## Page 16

- 7.1 Fixez (11) à (A), (B) et (C), avec (10) comme illustré.
- 7.2 Fixez (Y) à (A), (B) et (C) comme illustré.

ATTENTION : Ne serrez pas trop le tube de support pour éviter d'endommager la carte.

## Page 17

- 8.1 Insérez (2) à (U) et (V) comme illustré.
- 8.2 Attachez (D), (E) et (F) à l'échantillon à l'étape précédente avec (8) et (9) comme illustré.

## Page 18

- 9.1 Attachez (K) à (T) et (S) avec (16) comme illustré.
- 9.2 Fixez (L) à (M) et (N) avec (16) comme illustré.
- 9.3 Fixez (K)-(S)-(T) à (L)-(M)-(N) avec (16) comme illustré.

## Page 19

- 10.1 Attachez l'échantillon à l'étape (9) à (D), (E) et (F) avec (16) comme illustré.

## Page 20

- 11.1 Joindre (W) à (Q); (X) à (R) avec (16) comme illustré.

## Page 21

- 12.1 Attachez (Q)-(W) et (R)-(X) à l'échantillon à l'étape 10 avec (16) comme illustré.

## Page 22

- 13.1 Fixez (Z) au cadre avec (7) comme illustré.
- Remarque : veuillez vérifier et serrer toutes les vis dans cette étape.

## Page 23

- 14.1 Attachez (G), (H) et (I) à l'échantillon de l'étape précédente avec (8) comme illustré.
- Remarque : veuillez vérifier et serrer toutes les vis dans cette étape.
- AVERTISSEMENT : risque de mort ou de blessures graves. Cette surface doit être placée contre un mur fixe au moins aussi haut que la télévision

## Page 24

- 15.1 Insérez (14) dans le cadre comme illustré.
- 15.2 Mettez (J) sur la tige de la tablette (14) comme illustré.

## Page 25

- 16.1 Attachez (O), (P) à l'échantillon de l'étape précédente avec (7) comme illustré.
- 16.2 Fixez (13) à (O), (P) avec (5) comme illustré.

## Page 26

Instruction de réglage de la charnière de porte

## Page 27

### AVERTISSEMENT DE SÉCURITÉ POUR LE FOYER :

Si les informations contenues dans le manuel d'utilisation du fireplace ne sont pas suivies, un choc électrique ou un incendie peut entraîner des dommages matériels, des blessures corporelles ou la mort.

### RISQUE DE BASCULEMENT :

Risque de mort ou de blessures graves. Cet appareil doit être placé contre un mur fixe au moins aussi haut que la télévision.

## Page 28

### CHARGES MAXIMALES

Ce meuble a été conçu pour supporter les charges maximales indiquées. En excédant ces limites de charge, le meuble pourrait devenir instable, s'effondrer, et/ou causer des blessures graves.

AVERTISSEMENT: Appliquez l'étiquette d'avertissement du téléviseur sur votre appareil afin d'avoir toujours les limites de poids et de taille du téléviseur du modèle.

Taille maximale du téléviseur : écran plat 70", 120 lbs/54,5 kg.

## Page 29

Enregistrez votre produit pour recevoir les éléments suivantes:

- \* Détails sur les nouvelles tendances - un aperçu sur les nouveautés
- \* Sondages - avoir une voix au sein de notre communauté
- \* Offres exclusives et codes promo
- \* Service de pièces de rechange rapide et facile

Pour enregistrer votre produit, visitez [ameriwoodhome.com](http://ameriwoodhome.com)

### 5 Étoiles

Visitez le site Web de votre détaillant local, évaluez le produit que vous avez acheté et laissez-nous vos commentaires !

Nous tenons à offrir un grand "Merci" à tous nos clients pour avoir pris le temps d'assembler ce produit "Ameriwood Home", et de nous donner vos commentaires précieux.

Merci